

# FusionKraft™

General Surgery  
Instruments Catalogue



[www.myraandcompany.in](http://www.myraandcompany.in)

Myra & Co.  
*launches*

# FusionKraft™

General Vascular

Ophthalmic

Neuro

Plastic

Micro

Cardiac

Thoracic

ENT Gynaecology

Orthopaedics

# CONTENTS

Abdominal Retractors	44-45	Pelvimeters	57
Amputating & Resection Saws	70-71	Percussion Hammers	06
Anal Retractors, Rectal Specula		Plaster-of-Paris Knives	03
Sphinteroscopes, Anoscope, Proctoscopes	39-41	Plaster Shears, Bandage & Utility Scissors	70
Antrum Punch Forceps, Sphenoid Punches	66	Plaster Cast Instruments, Knives, Saws	70
Artery & Hysterectomy Forceps	24-25	Polypus & Foreign Body Forceps	33
Aspirating Curettes	65	Polypus & Sponge Holding Forceps	29
Atrauma Sigmoid Anastomosis Forceps	63	Prostatic Retractors	38
Atrauma Intestinal & Stomach Clamp Forceps	63-64	Prostatectomy Instruments	61
Autopsy, Amputating, Dissecting etc. (Knives)	01-03		
		Rib Spreaders	42-44
Bladder Retractors	42	Rib Shears	73
Bronchus Forceps, Ligature Forceps	65	Rhinoplastic Knives	03
Bone Curettes	69	Rhinoplastic Instruments	34-40
Bone Punches	66	Rectal Biopsy Specimen Forceps	61
Bone Levers	72		
Bone Cutting Forceps	74-75	Sensibility Instruments	06
Bone Rongeur Forceps	74-76	Scalpel Handles	01
Bone Holding Forceps, Retractors	71-72	Septum Compression Forceps	65
Bone Holding Clamps	61	Scissors	10-14, 70
Bone & Rib Shears	73	Splinter Forceps	19
Bronchoscopic Forceps	32	Sponge Holding Forceps	29-30
		Sterilizing Forceps	28
Capsular Forceps	21	Suture Instruments	21-23
Catheter Introducing Instruments	53	Suction Tubes	08
Cataract, Dicission Knives, Keratomes	03	Suction Biopsy Curettes	56
Cheek & Lip Retractors, Tongue Depressors, Mouth Gags	31		
Cilia Forceps	18	Tenaculum Forceps	52, 54-55
Clip Applying Forceps	66	Tissue Forceps	16-19
Curettes & Spoons	07	Tissue & Organ Holding Forceps	29
		Trachea Tubes	08
Diagnostics	04	Trocars	09
Dissecting Scissors	11-12	Towel Forceps	28
Dissecting Knives	01-02	Tongue Holding Forceps	30
Dissecting Sets	05	Tuning Forks	06
Dilating Bougies, Metal Catheters	53		
Dressing Forceps	15-16	Umbilical Scissors	14
		Uterine Dilators	62
Eye Knives	03	Uterine Scoops	57
Eye Scissors	13	Uterine Sounds & Depressors	56
ENT Scissors	13	Ureter Calculus Forceps	60
Ear Polypus Forceps, Ear Dressing Forceps, Ear Polypus Snares	32-33	Uterine Polypus Forceps	54
Extension Bows	77		
Gall Stones Forceps, Catheter & Scoops			
Probes & Gall Duct Dilators	58-60		
Operating Scissors	10-11, 12-14		
Ovum Curettes, Abortion Scoops	56-57		
Operating, Amputating Knives	01		
Obstetrical (Mid-Wifery) Forceps	51		

## SCALPEL HANDLES

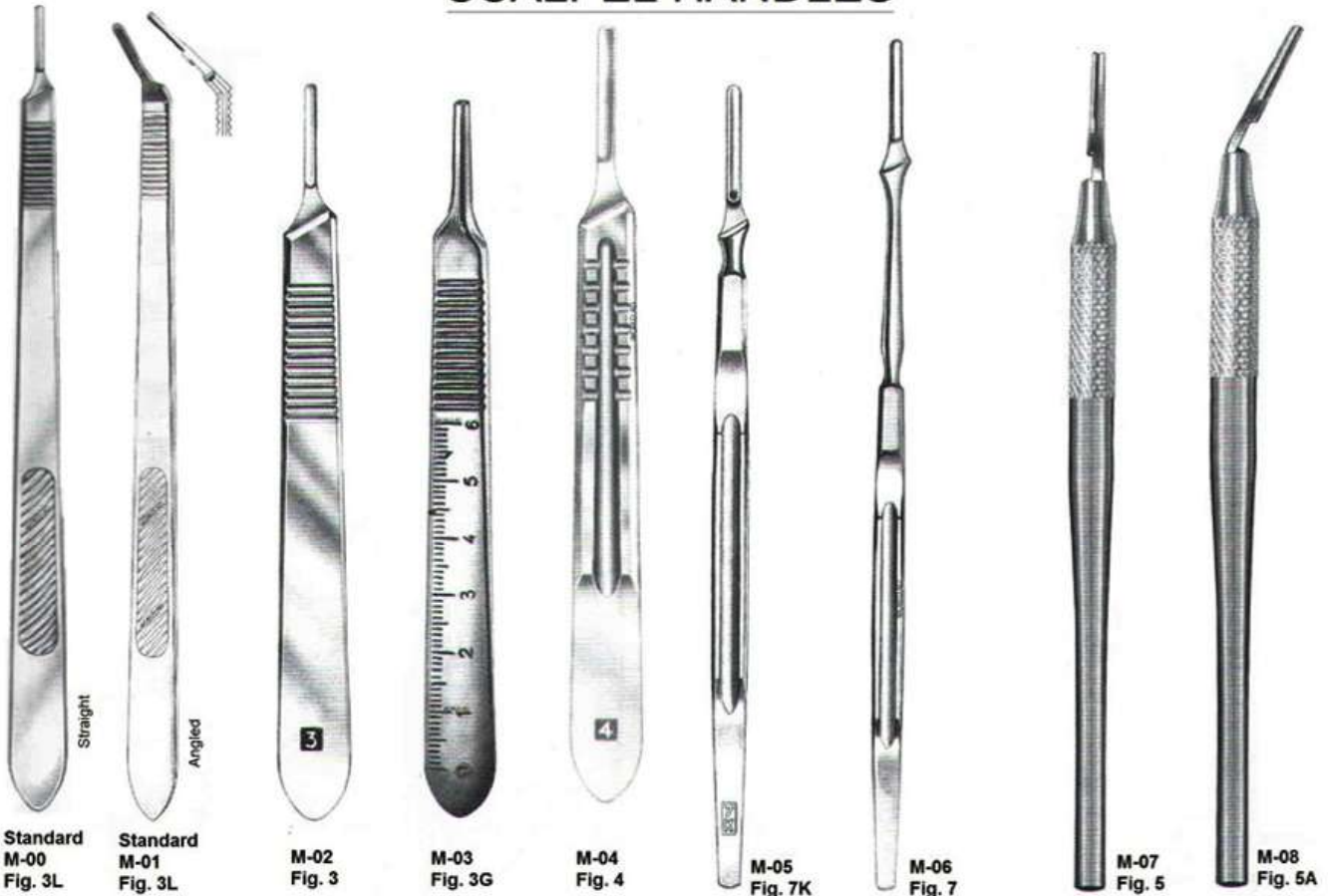

Standard  
M-00  
Fig. 3L

Standard  
M-01  
Fig. 3L

M-02  
Fig. 3

M-03  
Fig. 3G

M-04  
Fig. 4

M-05  
Fig. 7K

M-06  
Fig. 7

M-07  
Fig. 5

M-08  
Fig. 5A

## DISSECTING KNIVES

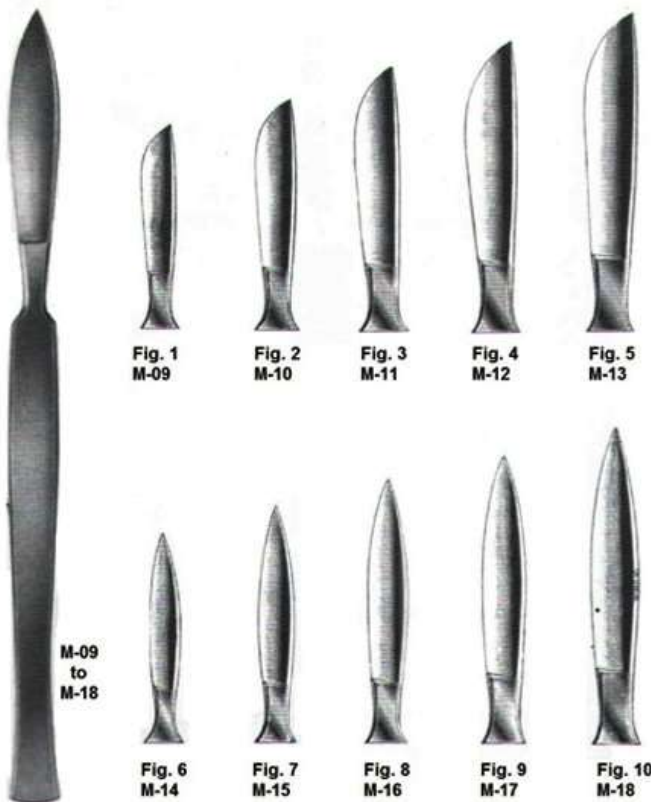

Fig. 1  
M-09

Fig. 2  
M-10

Fig. 3  
M-11

Fig. 4  
M-12

Fig. 5  
M-13

M-09  
to  
M-18

Fig. 6  
M-14

Fig. 7  
M-15

Fig. 8  
M-16

Fig. 9  
M-17

Fig. 10  
M-18

## OPERATING, AMPUTATING KNIVES

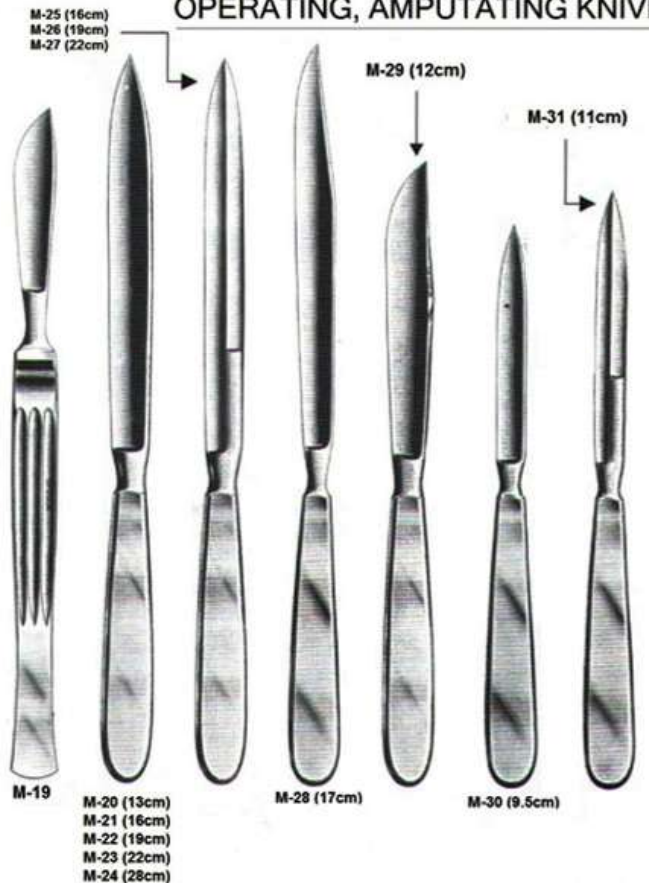

M-25 (16cm)  
M-26 (19cm)  
M-27 (22cm)

M-19

M-20 (13cm)  
M-21 (16cm)  
M-22 (19cm)  
M-23 (22cm)  
M-24 (28cm)

M-28 (17cm)

M-29 (12cm)

M-31 (11cm)

M-30 (9.5cm)

**RESECTION KNIVES**

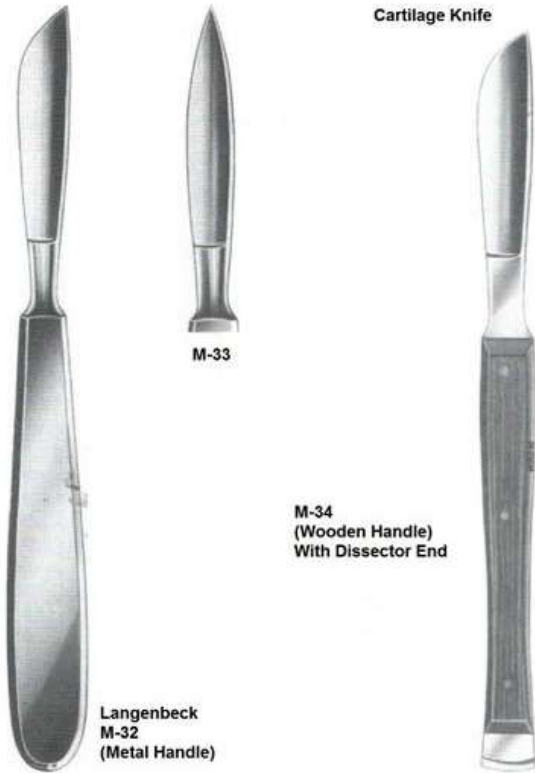

**AUTOPSY KNIVES**

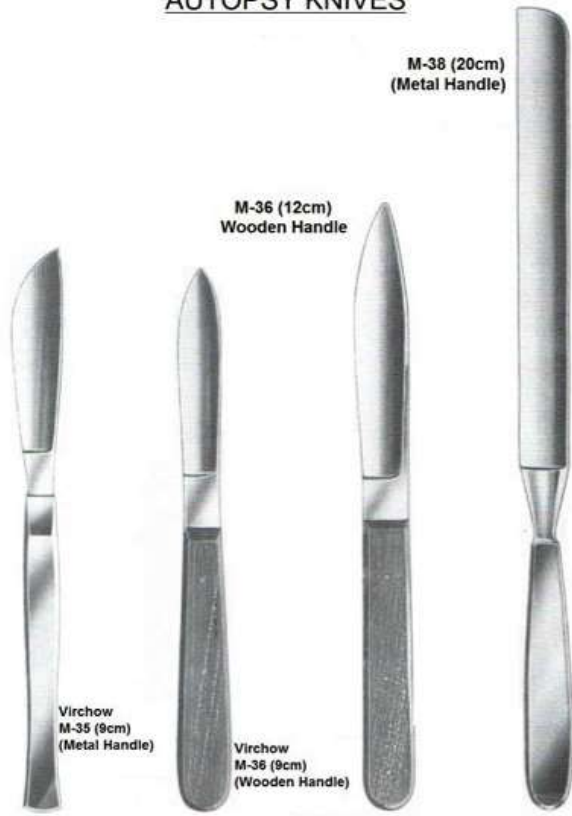

**POST-MORTEM & BRAIN KNIFE**



**DISSECTING KNIVES**



PLASTER-OF-PARIS KNIVES



EYE KNIVES

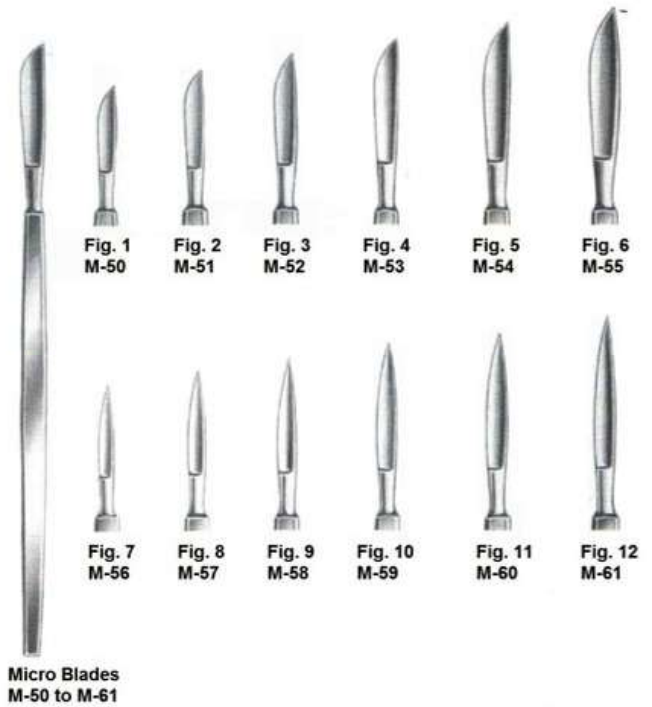

CATARACT, DIACISSION KNIVES, KERATOMES

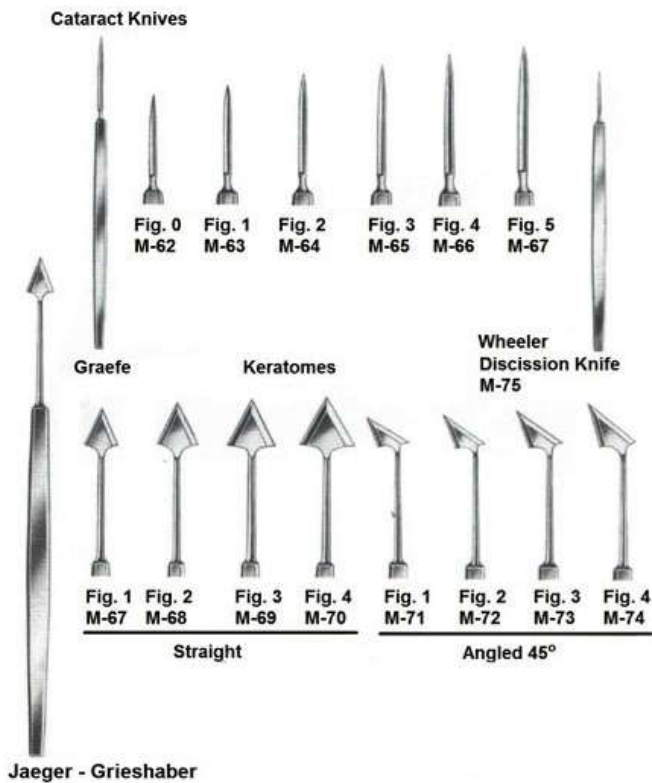

RHINOPLASTIC KNIVES

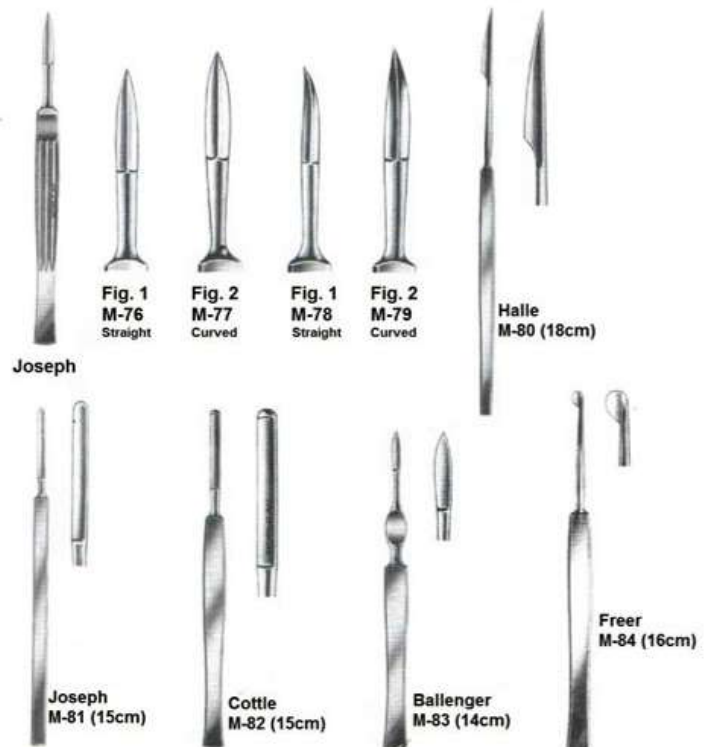

**DIAGNOSTICS**

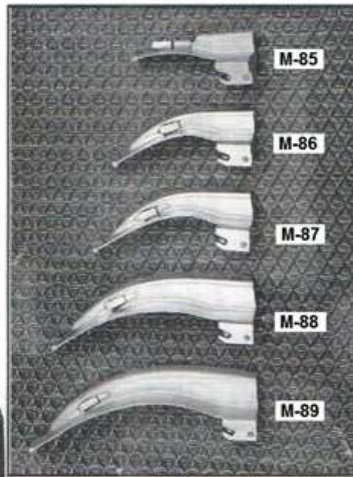

**McIntosh**



**McIntosh  
Laryngoscope Set  
M-90**

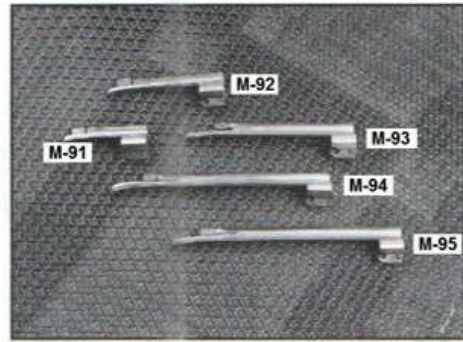

**Miller**



**Miller  
Laryngoscope Set  
M-96**



**Otoscope Set  
M-97  
Consisting of Battery Handle  
(without battery) 3 Ear Specula, 1 Bulb**



**Diagnostic Set  
(ENT Complete)  
M-98  
Consisting of :  
Battery Handle (without battery),  
3 Ear Specula,  
1 Nasal Specula,  
2 Laryngeal Mirrors with holder,  
1 Tongue Depressor Holder,  
1 Bulb**

**DISSECTING SETS**

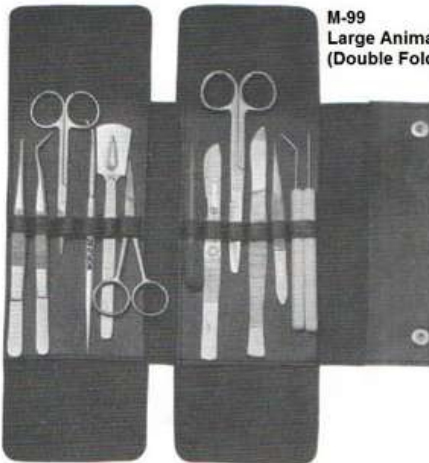

**M-99**  
Large Animal Set  
(Double Folding Leather Case)

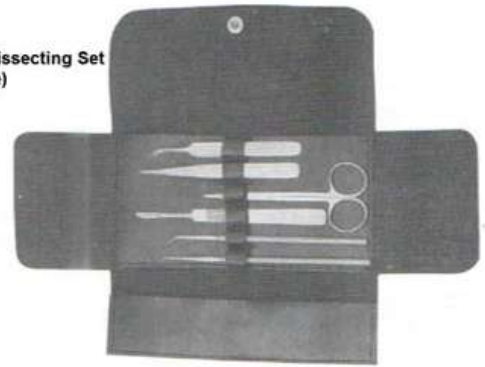

**M-101**  
Tissue Culture Dissecting Set  
(Lestherette Case)

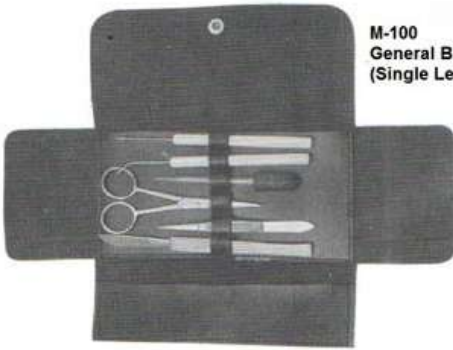

**M-100**  
General Biology Dissecting Set  
(Single Leather Case)

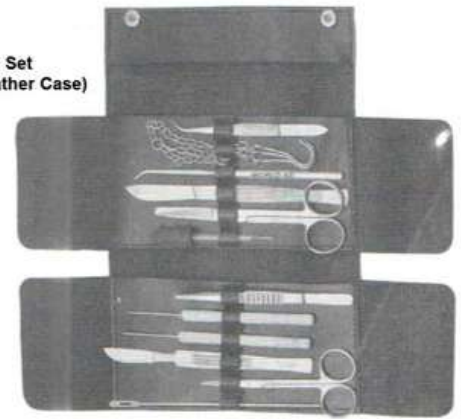

**M-102**  
Anatomy Dissecting Set  
(Double Folding Leather Case)

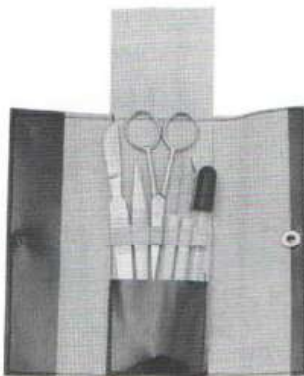

**M-103**  
Basic Dissecting Sets  
(Vinyl Pouch)



**M-105**  
Anatomy Dissecting Set  
(Double Folding Leather Case)

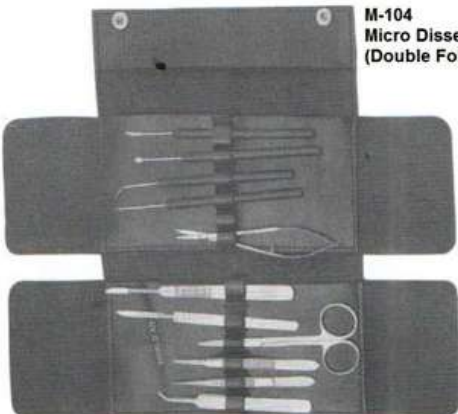

**M-104**  
Micro Dissecting Set  
(Double Folding Leather Case)

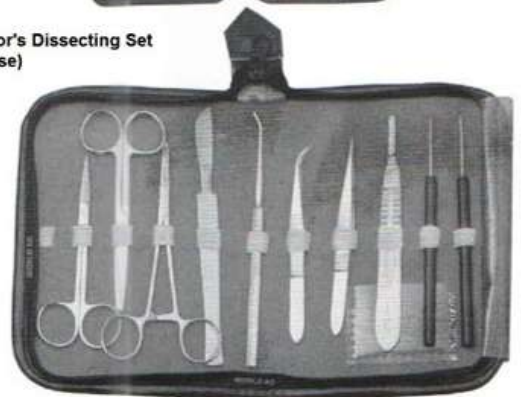

**M-106**  
New Instructor's Dissecting Set  
(Zippered Case)



**PERCUSSION HAMMERS**

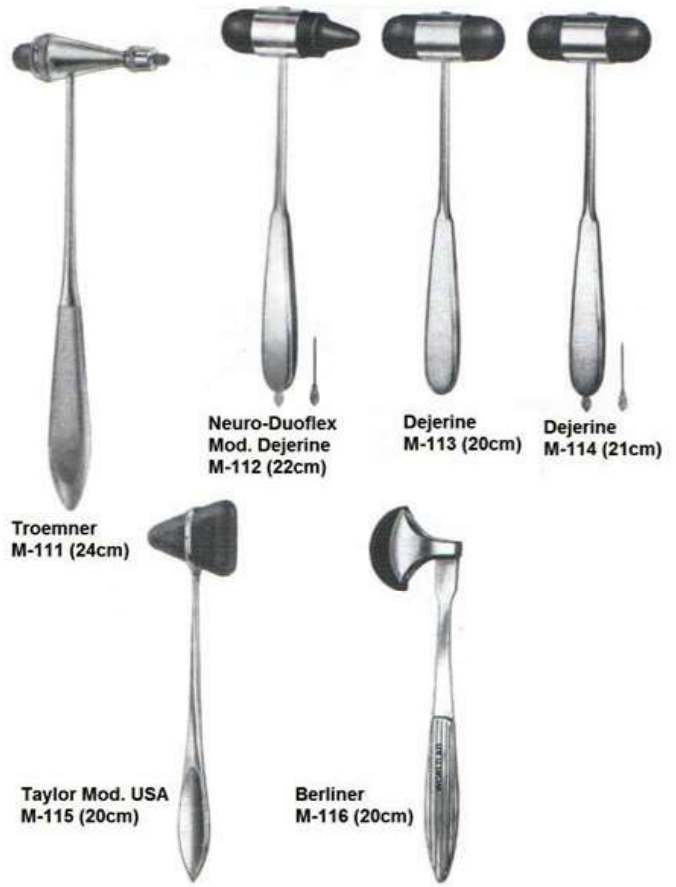

**SENSIBILITY INSTRUMENTS**

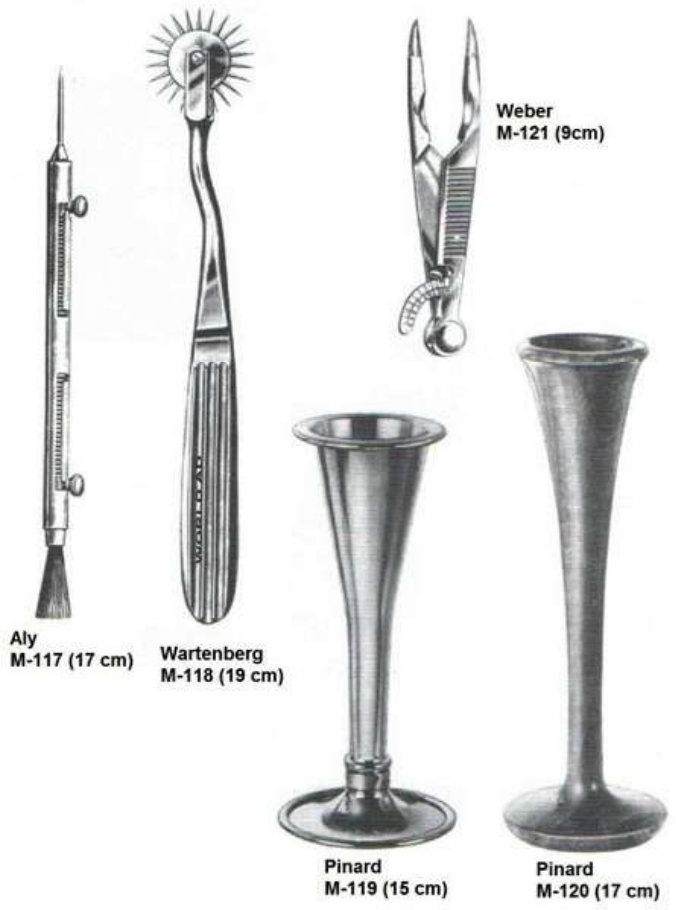

**TUNING FORKS**

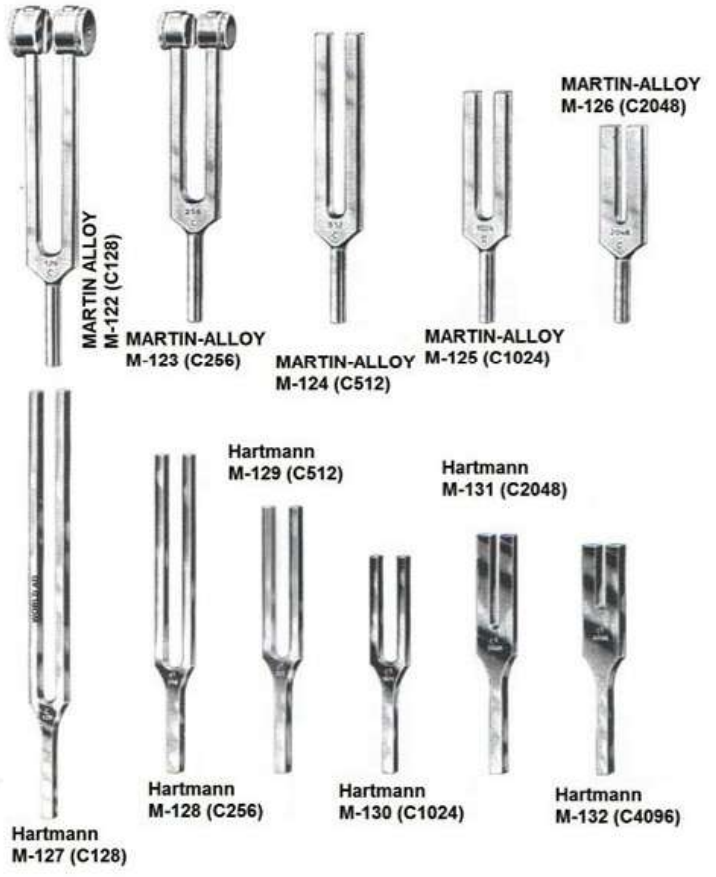

**PROBES**

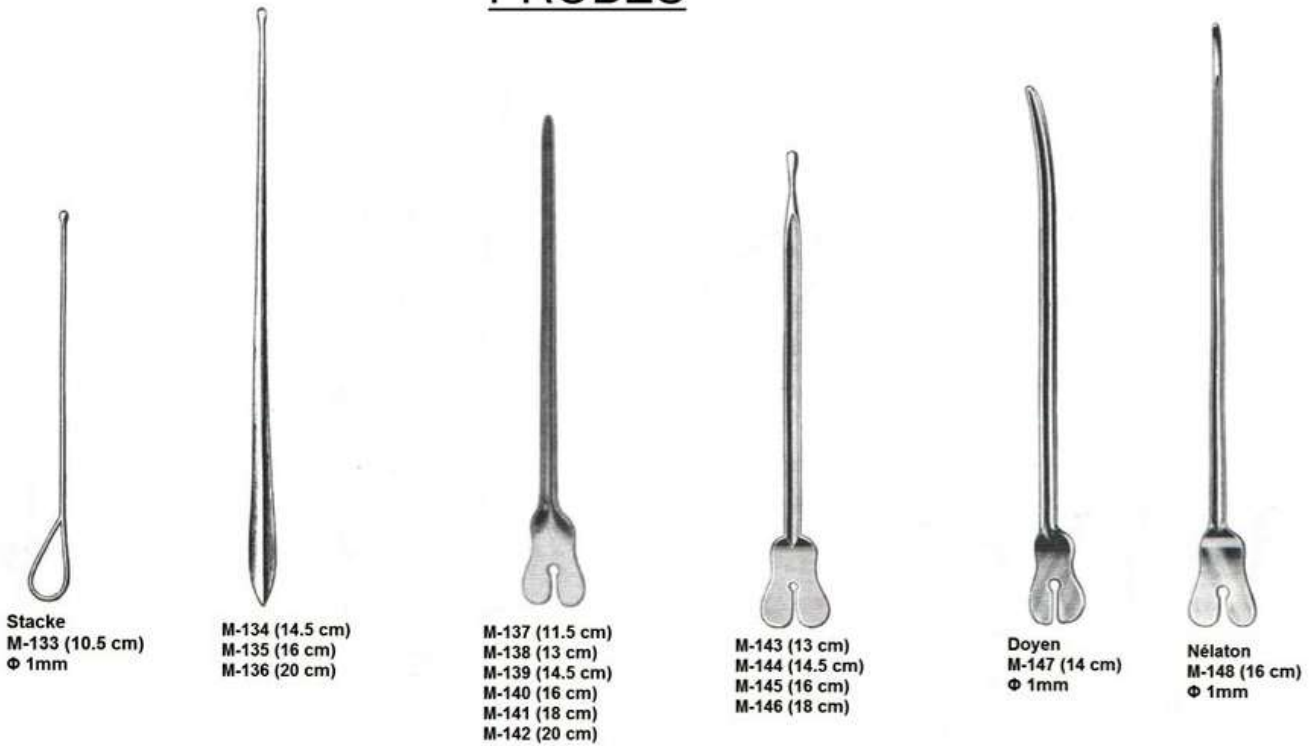

**CURETTES**

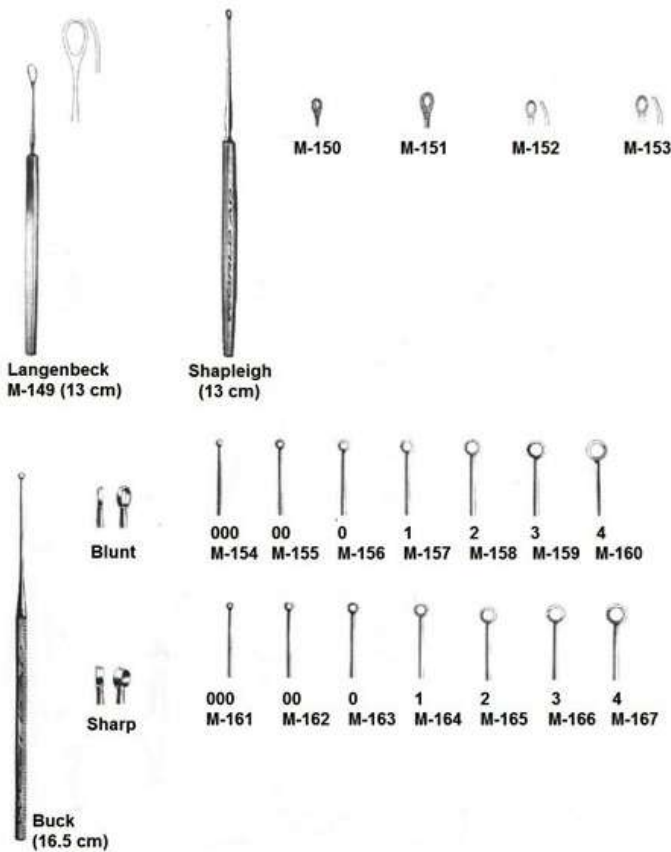

**CURETTES & SPOON**

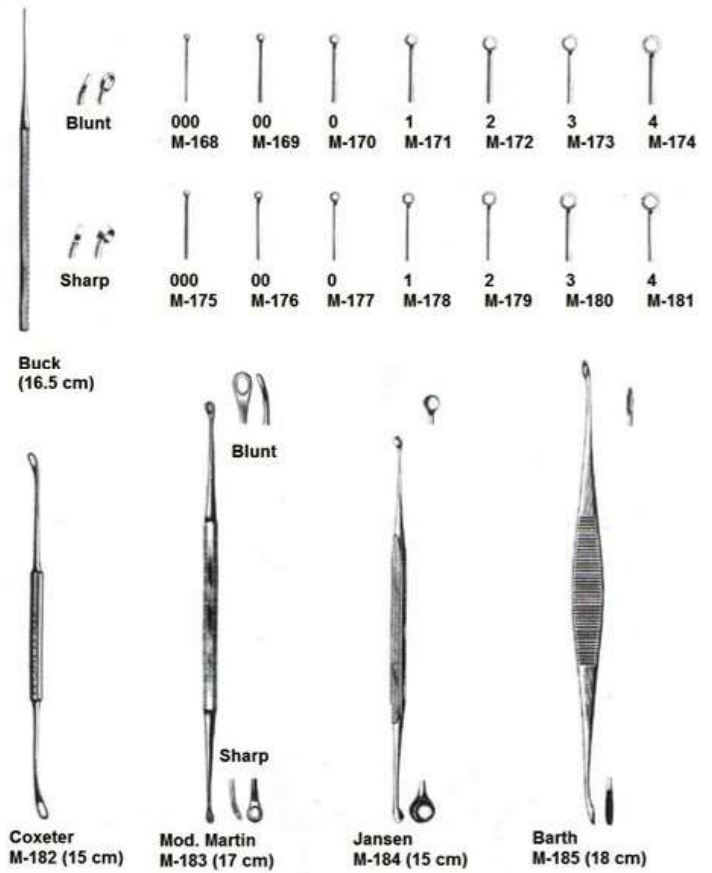

**SUCTION TUBES**

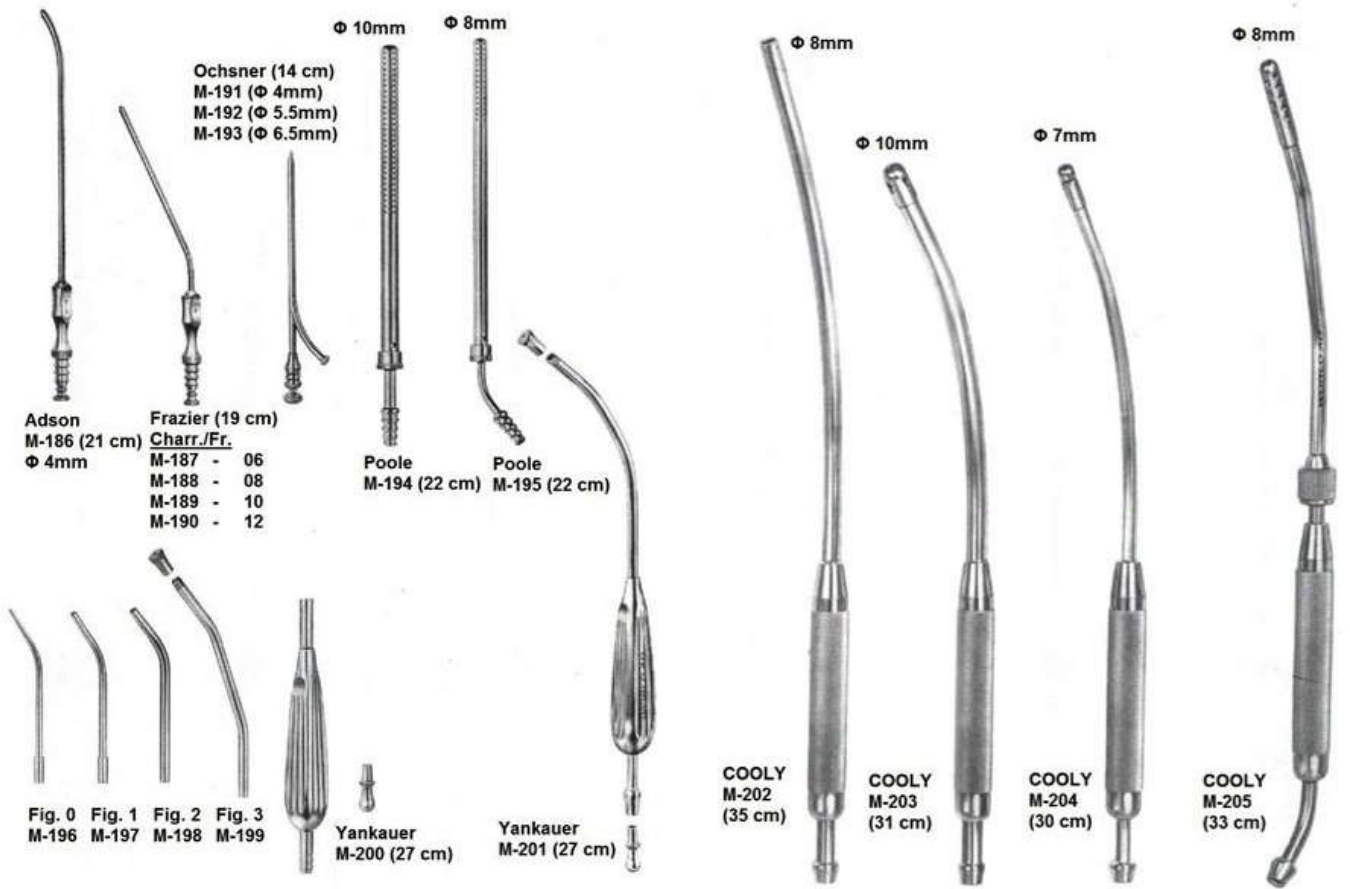

**TRACHEA TUBES**



**CATHETER INTRODUCING TUBES**



**TROCARS**



**Landau**  
M-210  
Φ 2mm



**Lichtwitz**  
M-211  
Φ 1.8mm



**Pierce**  
M-212  
Φ 4mm



**Duke**  
M-217 (11 cm)  
Φ 5.5mm



**Nelson**  
21 cm



M-218



M-219



M-220



**Krause**  
M-213  
Φ 5.5mm



**Coakley**  
M-214  
Φ 2.25mm



**Douglas**  
M-215  
Φ 3mm



**Douglas**  
M-216 (11 cm)



**Campbell**  
16 cm



M-221  
Φ 6mm



M-222  
Φ 8mm



**Beulau**  
M-223  
Φ 8mm



**Universal**  
M-224 (Set of 3 pcs.)  
M-225 (Set of 4 pcs.)



**Fleurant**  
M-238 (23 cm)  
Φ 5mm

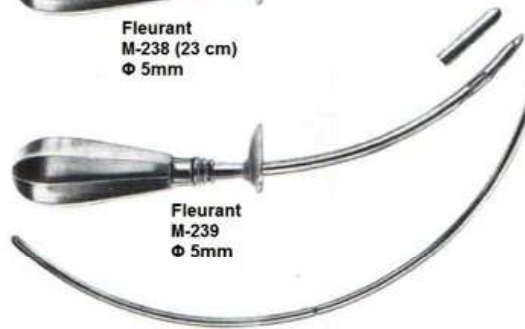

**Fleurant**  
M-239  
Φ 5mm



**Billorth**  
M-240 (24 cm)  
Φ 6mm



**Standard (11 cm)**  
M-226 (Φ 3mm)  
M-227 (Φ 4mm)  
M-228 (Φ 5mm)  
M-229 (Φ 6mm)



**Standard (12 cm)**  
M-230 (Φ 3mm)  
M-231 (Φ 4mm)  
M-232 (Φ 5mm)  
M-233 (Φ 6mm)



**Standard (12 cm)**  
M-234 (Φ 3mm)  
M-235 (Φ 4mm)  
M-236 (Φ 5mm)  
M-237 (Φ 6mm)



## OPERATING SCISSORS

Straight



**STANDARD**  
 M-241 (10.5 cm)  
 M-242 (11.5 cm)  
 M-243 (13.0 cm)  
 M-244 (14.5 cm)  
 M-245 (15.5 cm)  
 M-246 (16.5 cm)  
 M-247 (17.5 cm)  
 M-248 (18.5 cm)  
 M-249 (20.0 cm)

Straight



**STANDARD**  
 M-250 (10.5 cm)  
 M-251 (11.5 cm)  
 M-252 (13.0 cm)  
 M-253 (14.5 cm)  
 M-254 (15.5 cm)  
 M-255 (16.5 cm)  
 M-256 (17.5 cm)  
 M-257 (18.5 cm)  
 M-258 (20.0 cm)

Straight



**STANDARD**  
 M-259 (10.5 cm)  
 M-260 (11.5 cm)  
 M-261 (13.0 cm)  
 M-262 (14.5 cm)  
 M-263 (15.5 cm)  
 M-264 (16.5 cm)  
 M-265 (17.5 cm)  
 M-266 (18.5 cm)  
 M-267 (20.0 cm)



**STANDARD**  
 M-268 (10.5 cm)  
 M-269 (11.5 cm)  
 M-270 (13.0 cm)  
 M-271 (14.5 cm)  
 M-272 (15.5 cm)  
 M-273 (16.5 cm)  
 M-274 (17.5 cm)  
 M-275 (18.5 cm)  
 M-276 (20.0 cm)



**STANDARD**  
 M-277 (10.5 cm)  
 M-278 (11.5 cm)  
 M-279 (13.0 cm)  
 M-280 (14.5 cm)  
 M-281 (15.5 cm)  
 M-282 (16.5 cm)  
 M-283 (17.5 cm)  
 M-284 (18.5 cm)  
 M-285 (20.0 cm)



**STANDARD**  
 M-286 (10.5 cm)  
 M-287 (11.5 cm)  
 M-288 (13.0 cm)  
 M-289 (14.5 cm)  
 M-290 (15.5 cm)  
 M-291 (16.5 cm)  
 M-292 (17.5 cm)  
 M-293 (18.5 cm)  
 M-294 (20.0 cm)



**Incision Scissor**  
 M-295 (13.0 cm)  
 M-296 (14.5 cm)

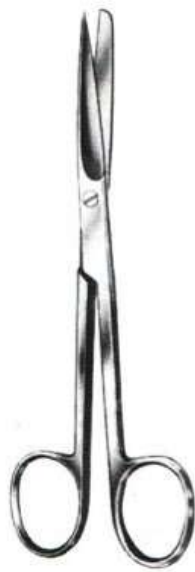

**Deaver Straight**  
 M-297 (14 cm)



**Deaver Curved**  
 M-298 (14 cm)



**Mayo - Still Straight**  
 M-299 (15 cm)  
 M-300 (17 cm)  
 M-301 (19 cm)



**Mayo - Still Curved**  
 M-302 (15 cm)  
 M-303 (17 cm)  
 M-304 (19 cm)



**Mayo Straight**  
 M-305 (14.5 cm)  
 M-306 (15.0 cm)  
 M-307 (17.0 cm)  
 M-308 (23.0 cm)



**Mayo Curved**  
 M-309 (15.0 cm)  
 M-310 (17.0 cm)  
 M-311 (19.0 cm)  
 M-312 (23.0 cm)

**OPERATING SCISSORS**

Gynaecological Scissor



**Mayo - Noble**  
Straight - M-313 (17 cm)  
Curved - M-314 (17 cm)



**Mayo - Still**  
Straight  
M-315 (16 cm)  
M-316 (19 cm)  
M-317 (21 cm)

**Mayo - Still**  
Curved  
M-318 (16 cm)  
M-319 (19 cm)  
M-320 (21 cm)

Gynaecological Scissor



**Wertheim**  
Curved  
M-321 (14 cm)  
M-322 (19 cm)  
M-232 (22 cm)

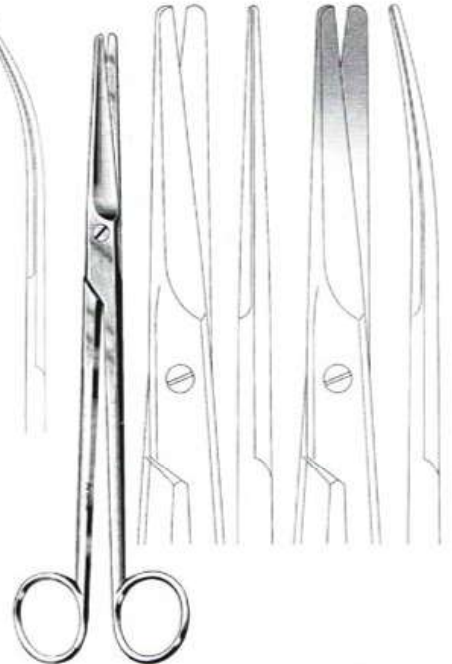

**Mayo - Harrington**  
Straight - M-324 (22 cm)  
Curved - M-325 (22 cm)  
M-326 (30 cm)

**DISSECTING SCISSORS**

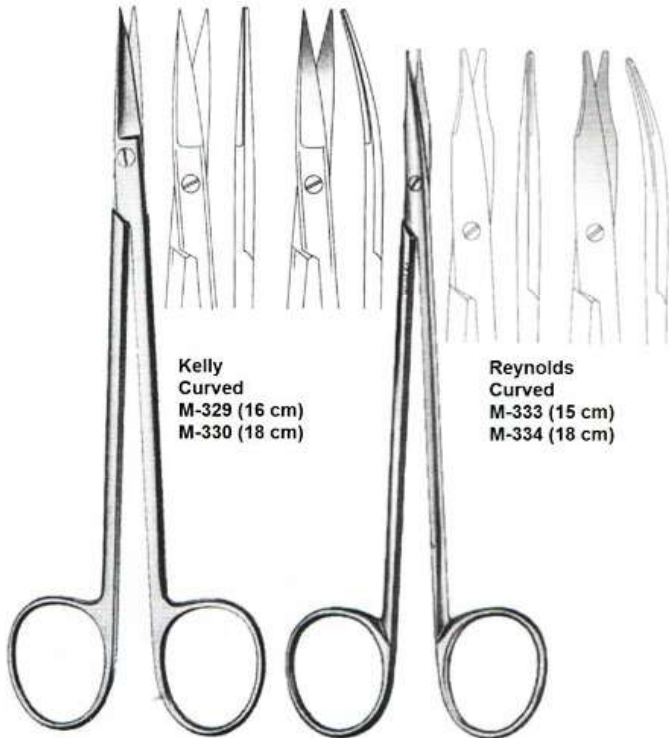

**Kelly**  
Curved  
M-329 (16 cm)  
M-330 (18 cm)

**Reynolds**  
Curved  
M-333 (15 cm)  
M-334 (18 cm)



**Kelly**  
Straight  
M-327 (16 cm)  
M-328 (18 cm)

**Reynolds**  
Straight  
M-331 (15 cm)  
M-332 (18 cm)

**DISSECTING SCISSORS**



**Metzzenbaum**  
Straight  
M-333 (14.5 cm)

**Metzzenbaum - Delikat**  
Straight  
M-337 (14.5 cm)

**Metzzenbaum**  
Curved  
M-336 (14.5 cm)

**Metzzenbaum - Delikat**  
Curved  
M-338 (14.5 cm)

DISSECTING SCISSORS

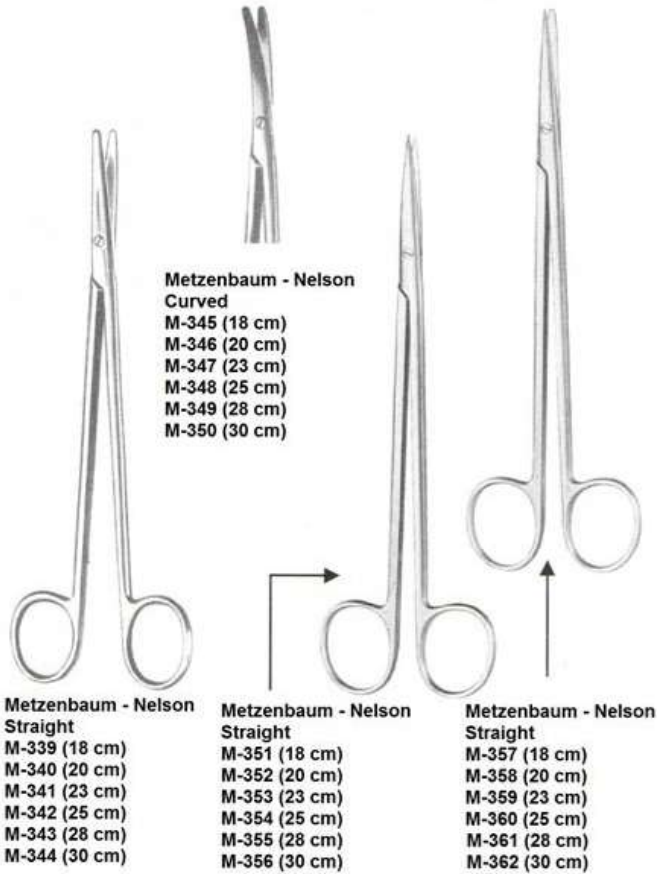

OPERATING SCISSORS

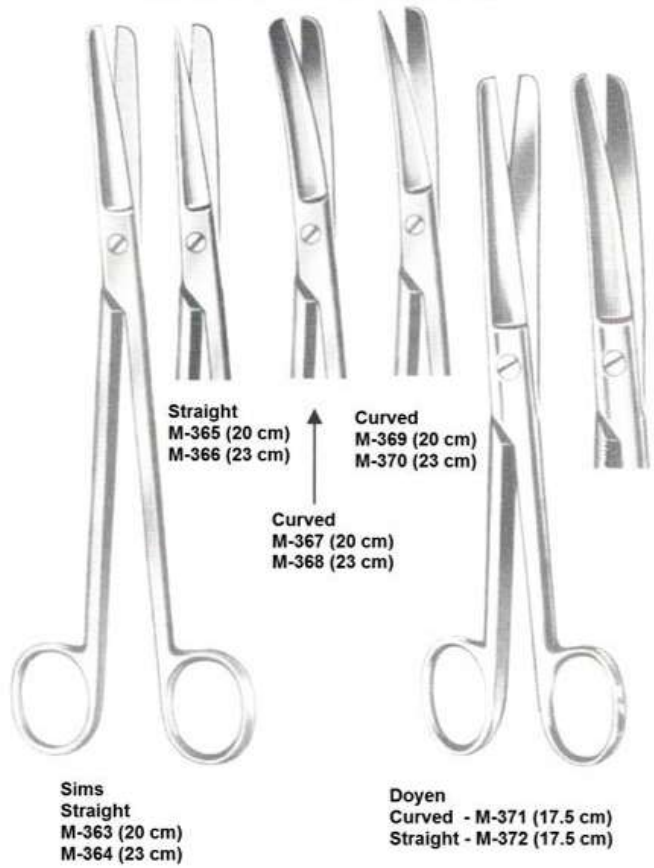

NEUROLOGICAL SCISSORS



NASAL SCISSORS

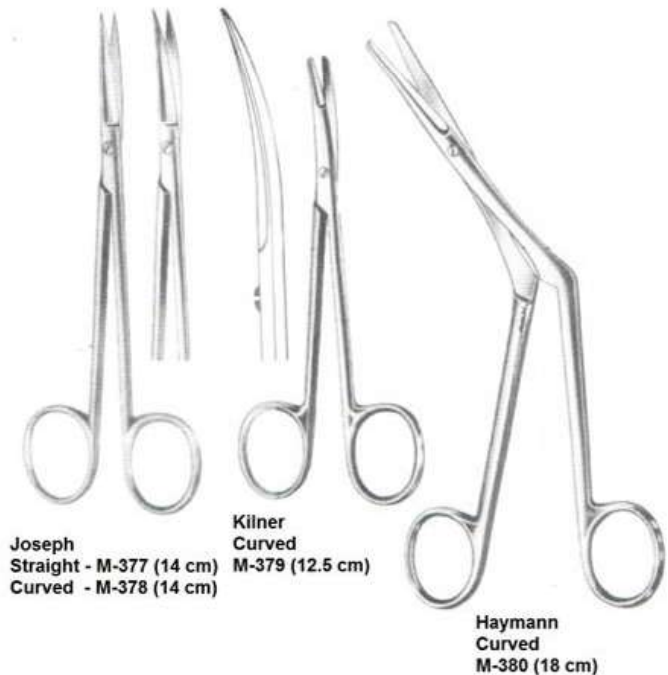

**EYE SCISSORS**



**Straight**  
 M-381 (9.0 cm)  
 M-382 (10.5 cm)  
 M-383 (11.5 cm)  
 M-384 (12.0 cm)  
**Curved**  
 M-385 (9.0 cm)  
 M-386 (10.5 cm)  
 M-387 (11.5 cm)  
 M-388 (12.0 cm)



**Laterally Curved** M-389 (11.5 cm) **Angled** M-390 (11.5 cm)

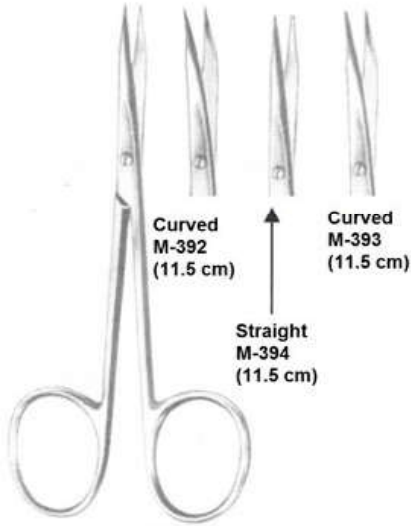

**Curved** M-392 (11.5 cm) **Curved** M-393 (11.5 cm)  
**Straight** M-394 (11.5 cm)  
**Stevens Straight** M-391 (11.5 cm)

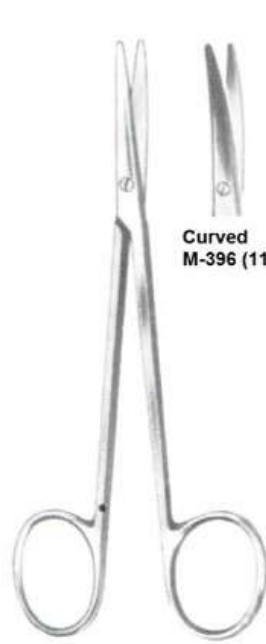

**Curved** M-396 (11.5 cm)

**Straight** M-395 (11.5 cm)

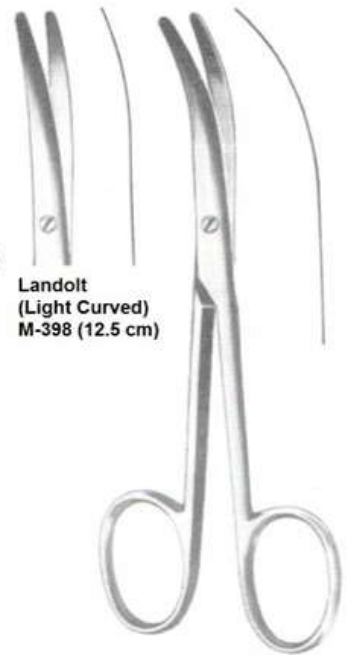

**Landolt (Light Curved)** M-398 (12.5 cm)

**Landolt Strong Curved** M-397 (12.5 cm)

**TONSIL SCISSORS**

**ENT SCISSORS**



**Quinby** M-399 (12.5 cm)

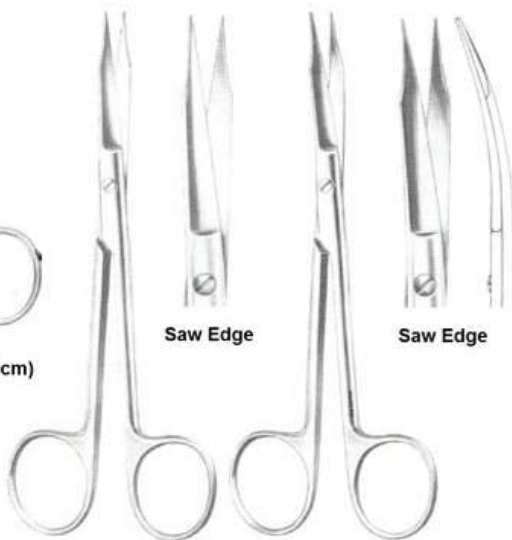

**Fox Straight** M-400 (13 cm)

**Fox Curved** M-401 (13 cm)

**Saw Edge**

**Saw Edge**



**Boettcher** M-402 (18 cm)

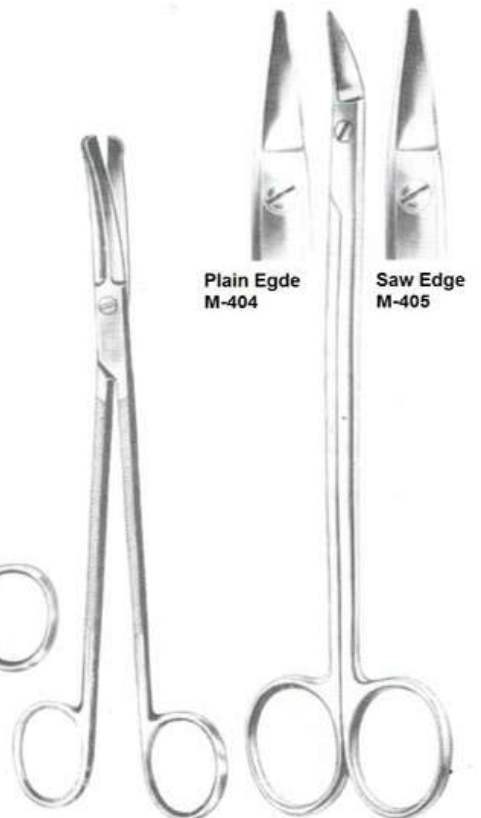

**Plain Edge** M-404

**Saw Edge** M-405

**Good** M-403 (19 cm)

**Dean** (17.5 cm)



LIGATURE / DISSECTING SCISSORS



UMBILICAL SCISSORS



OPERATING SCISSORS

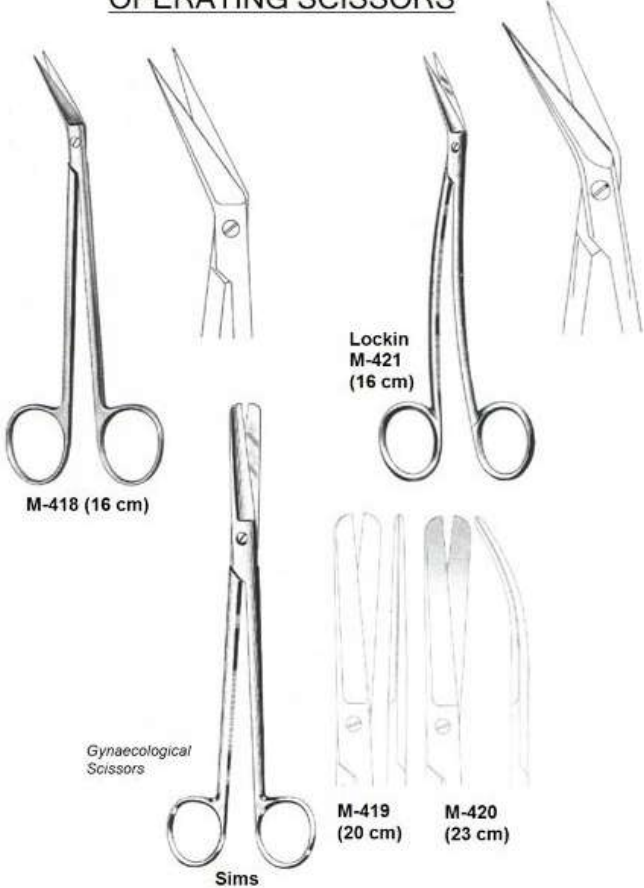

WIRE CUTTING, GUM SCISSORS

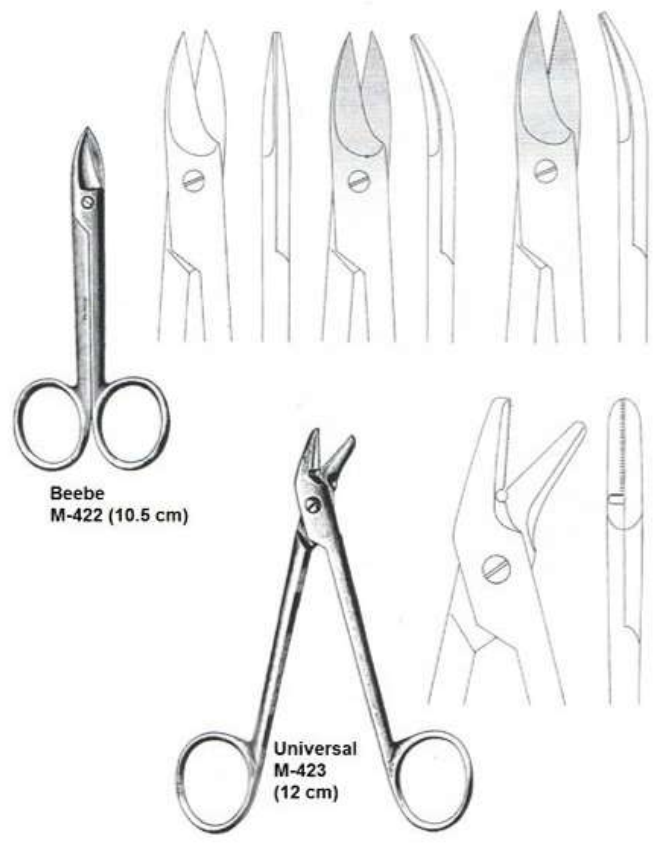

# DRESSING FORCEPS

**Standard**

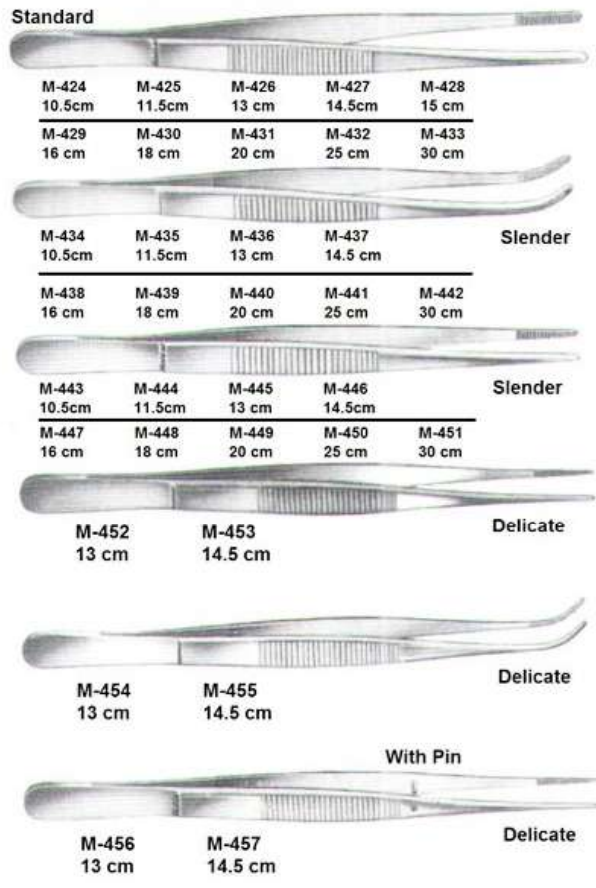

**Standard Mod. USA**

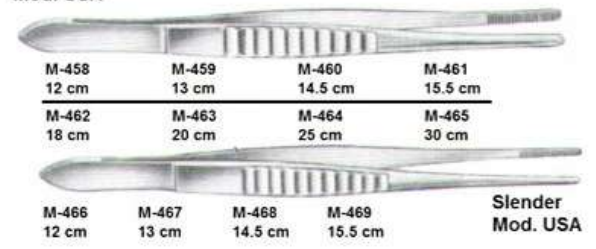

**Adson**



**Micro Adson**



**Stille M-474**



**McIndoe**



**Eng. Pattern**



**Semken**



**Taylor**



**Taylor**



**Taylor**



**Gerald**



**Gerald**



**Cushing**



**Cushing**



**Potts - Smith**



**Potts - Smith**



## DRESSING FORCEPS

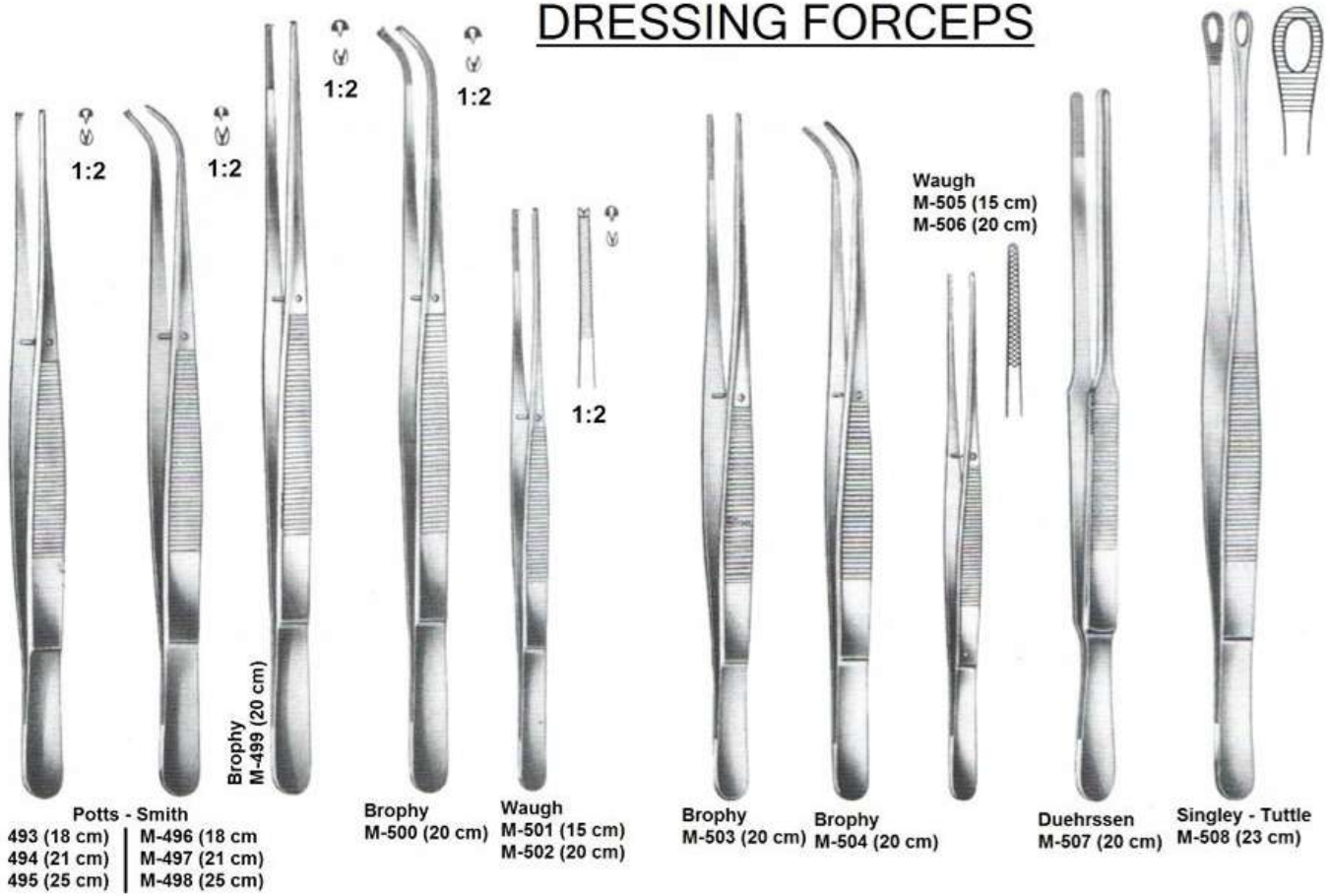

## TISSUE FORCEPS

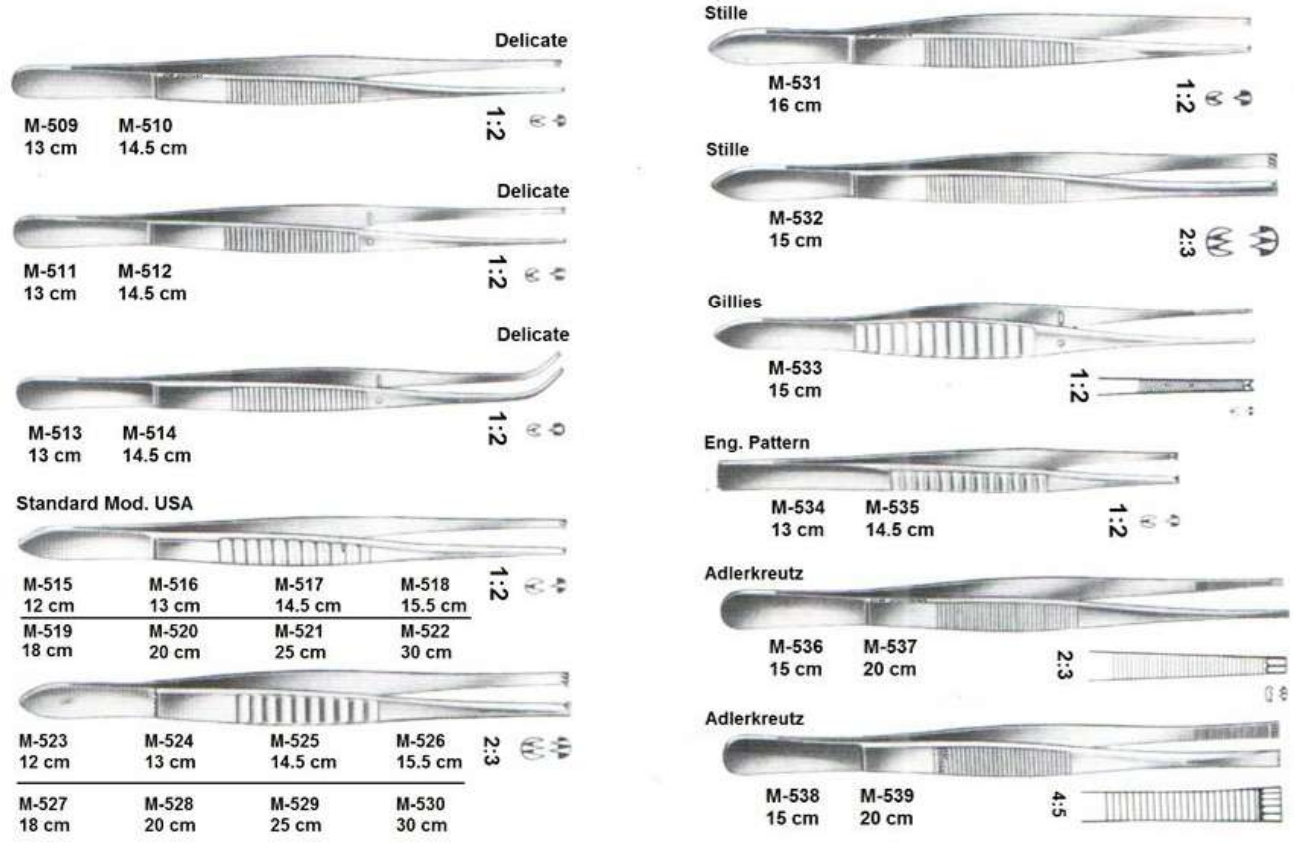

## TISSUE FORCEPS

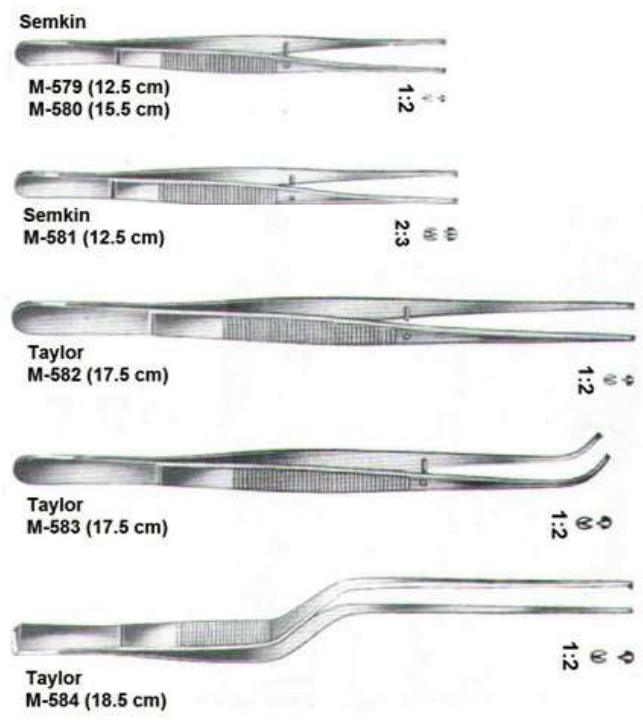
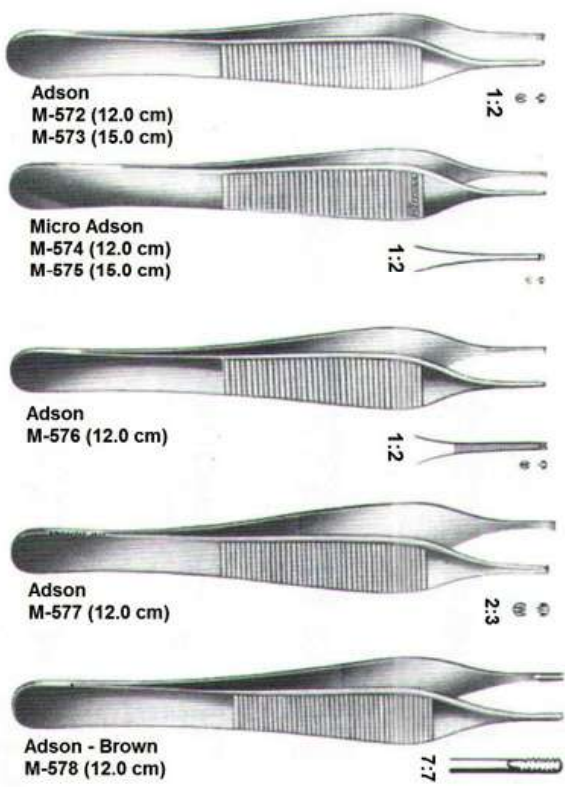
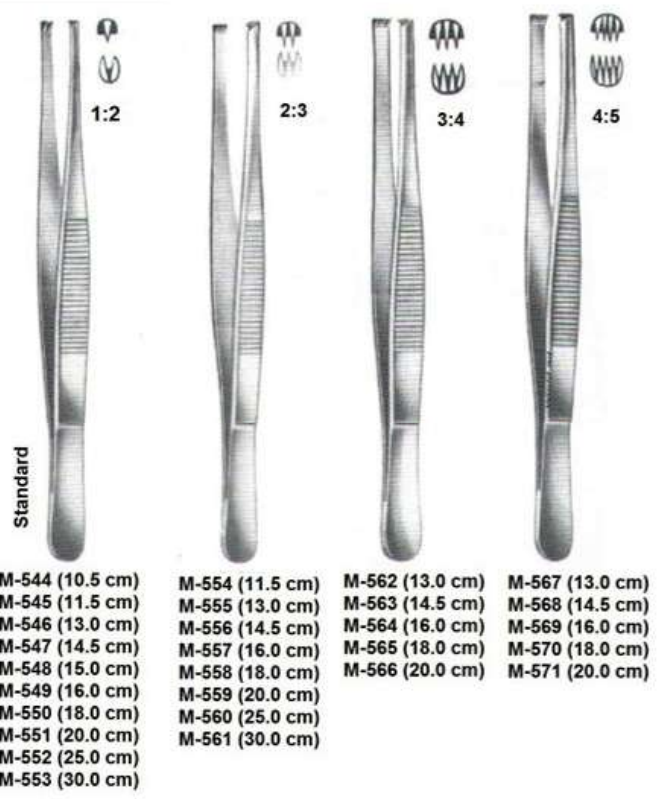
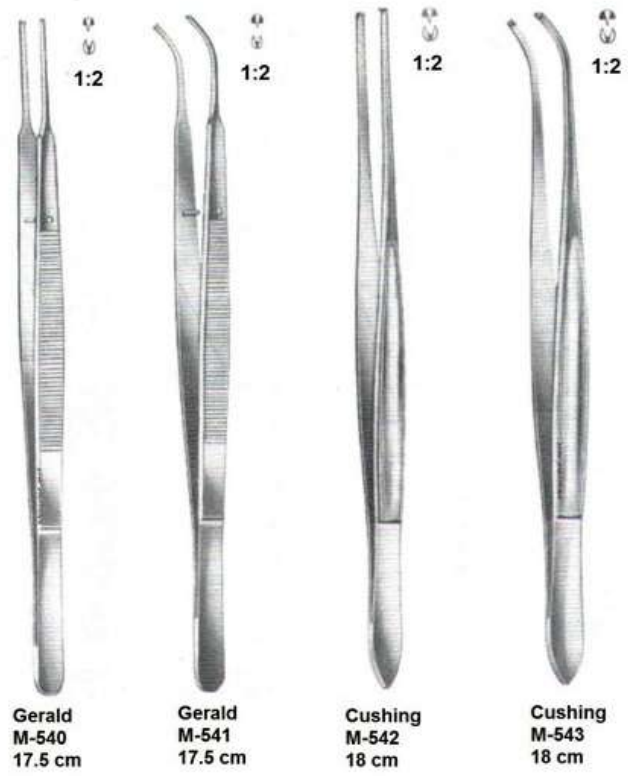

TISSUE FORCEPS

**Bonney  
M-585 (18 cm)**



1:2

**Bonney  
M-586 (18 cm)**



2:3



**Nelson  
M-587 (15 cm)  
M-588 (20 cm)  
M-589 (23 cm)**



1:2



2:3



7:7



1:2

**Lane  
M-590 (14.5 cm)  
M-591 (20 cm)**

**Lane  
M-592 (14.5 cm)  
M-593 (20 cm)**

**Brown  
M-594 (15 cm)  
M-595 (20 cm)**

**Treves  
M-596 (13 cm)  
M-597 (15 cm)**

CILIA FORCEPS



**Bergh  
M-598 (10.5 cm)**



**Barraquer  
M-599 (10.5 cm)**



**Gradle  
M-600 (10 cm)**



**Henny  
M-601 (10 cm)**



**M-602 (9 cm)**



**M-603 (9 cm)**



**Douglas  
M-604 (9 cm)**



**Douglas  
M-605 (9 cm)**



**Beer  
M-606 (6.5 cm)  
M-607 (8.0 cm)  
M-608 (9.0 cm)**

## SPLINTER FORCEPS

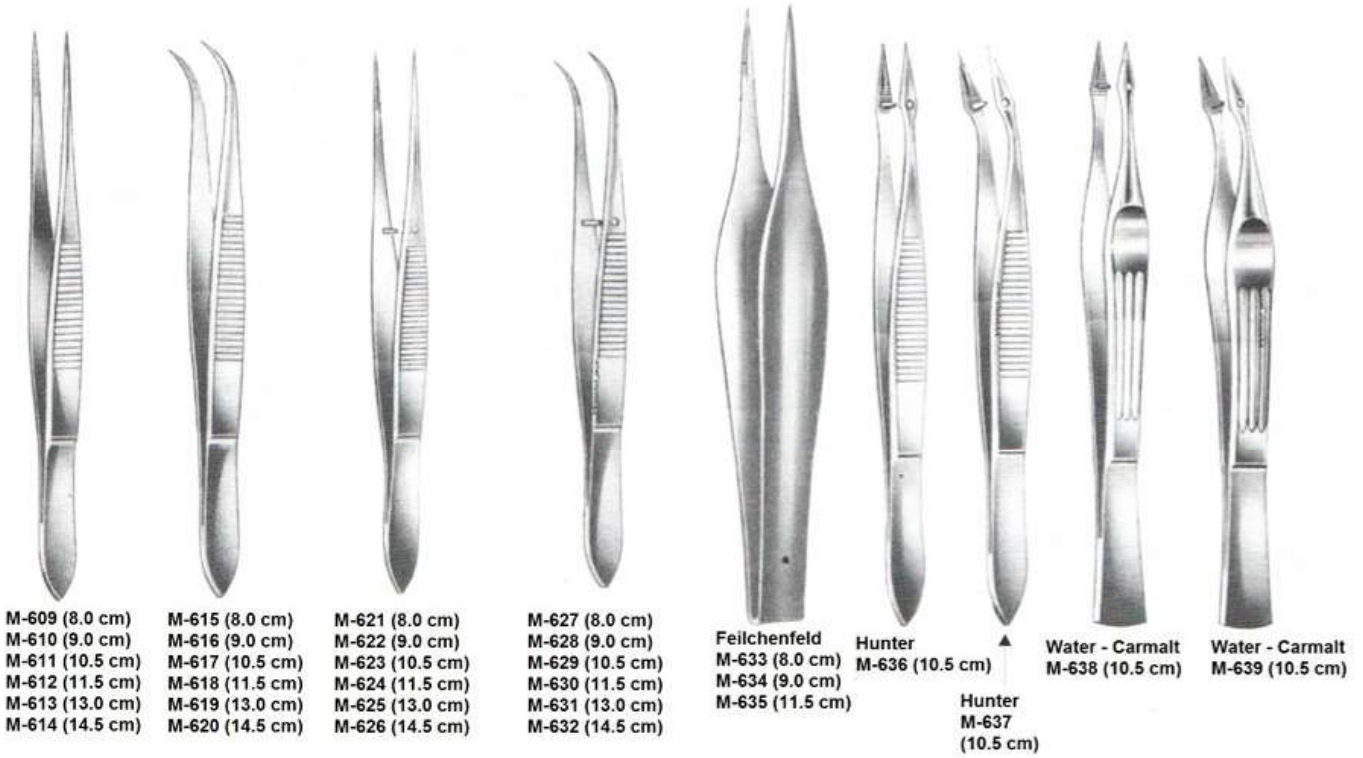

**M-609 (8.0 cm)**    **M-615 (8.0 cm)**    **M-621 (8.0 cm)**    **M-627 (8.0 cm)**    **Feilchenfeld**  
**M-610 (9.0 cm)**    **M-616 (9.0 cm)**    **M-622 (9.0 cm)**    **M-628 (9.0 cm)**    **M-633 (8.0 cm)**  
**M-611 (10.5 cm)**    **M-617 (10.5 cm)**    **M-623 (10.5 cm)**    **M-629 (10.5 cm)**    **M-634 (9.0 cm)**  
**M-612 (11.5 cm)**    **M-618 (11.5 cm)**    **M-624 (11.5 cm)**    **M-630 (11.5 cm)**    **M-635 (11.5 cm)**  
**M-613 (13.0 cm)**    **M-619 (13.0 cm)**    **M-625 (13.0 cm)**    **M-631 (13.0 cm)**    **Hunter**  
**M-614 (14.5 cm)**    **M-620 (14.5 cm)**    **M-626 (14.5 cm)**    **M-632 (14.5 cm)**    **M-636 (10.5 cm)**  
▲  
Hunter  
M-637  
(10.5 cm)  
**Water - Carmalt**    **Water - Carmalt**  
**M-638 (10.5 cm)**    **M-639 (10.5 cm)**

## TISSUE FORCEPS

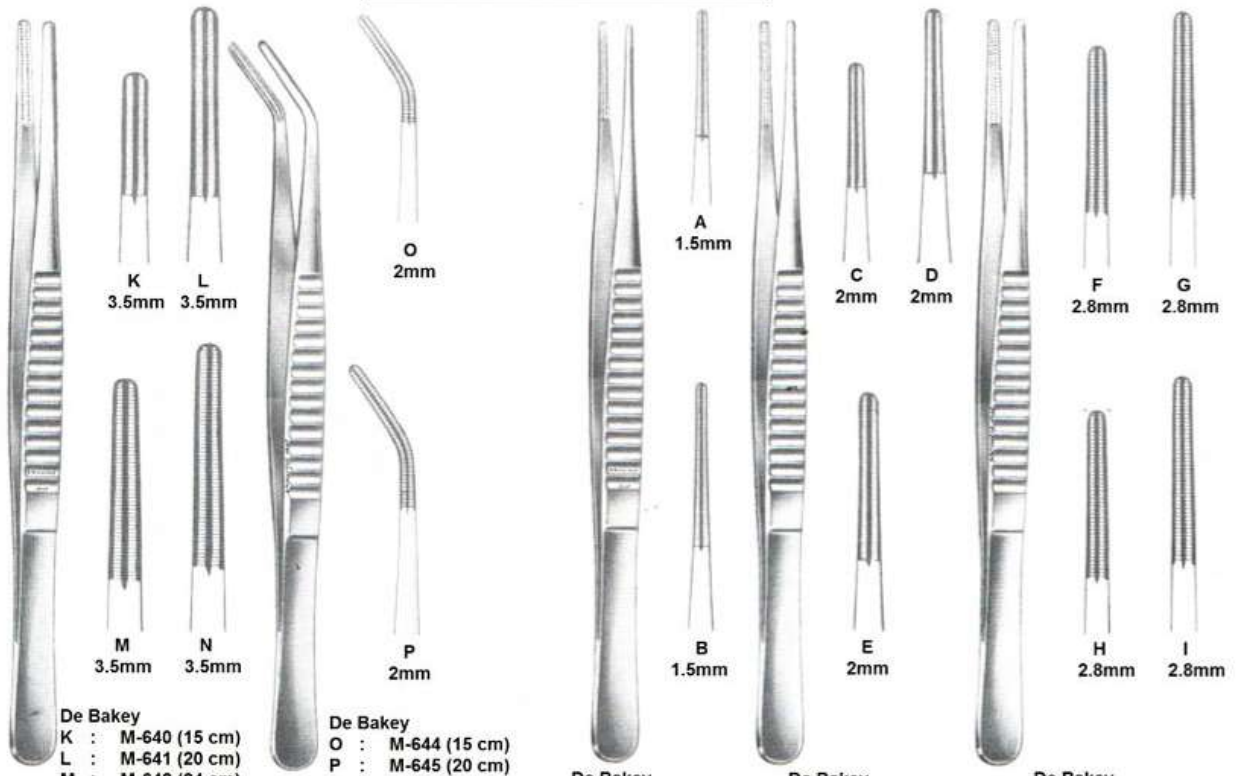

**De Bakery**  
**K : M-640 (15 cm)**  
**L : M-641 (20 cm)**  
**M : M-642 (24 cm)**  
**N : M-643 (30 cm)**

**De Bakery**  
**O : M-644 (15 cm)**  
**P : M-645 (20 cm)**

**De Bakery**  
**A : M-646 (15 cm)**  
**B : M-647 (20 cm)**

**De Bakery**  
**C : M-648 (15 cm)**  
**D : M-649 (20 cm)**  
**E : M-650 (24 cm)**

**De Bakery**  
**F : M-651 (15 cm)**  
**G : M-652 (20 cm)**  
**H : M-653 (24 cm)**  
**I : M-654 (30 cm)**

## IRIS FORCEPS



**Stevens**  
M-655 (10.5 cm)



**Stevens**  
M-656 (10.5 cm)



**Stevens**  
M-657 (10.5 cm)



**Stevens**  
M-658 (10.5 cm)

1:2



**Stevens**  
M-659 (10.5 cm)

1:2



**Stevens**  
M-660 (10.5 cm)

1:2



**Graefe**  
M-661 (7 cm)  
M-662 (10 cm)



**Graefe**  
M-663 (7 cm)  
M-664 (10 cm)



**Graefe**  
M-665 (7 cm)  
M-666 (10 cm)



**Graefe**  
M-667 (7 cm)  
M-668 (10 cm)

1:2



**Graefe**  
M-669 (7 cm)  
M-670 (10 cm)

1:2



**Graefe**  
M-671 (7 cm)  
M-672 (10 cm)

1:2



1:2

**Hess**  
M-673  
(9 cm)



1:2

**Hess**  
M-674  
(9 cm)



1:2

without  
guide pin

**Mod. Bonn**  
M-675  
(7 cm)



1:2

with  
guide pin

**Mod. Bonn**  
M-676  
(7 cm)



**Bishop-Harmon**  
M-677  
(8.5 cm)



**Bishop-Harmon**  
M-678  
(8.5 cm)



1:2

**Bishop-Harmon**  
M-679  
(8.5 cm)



1:2

**Bishop-Harmon**  
M-680  
(8.5 cm)

**SUTURE FORCEPS**

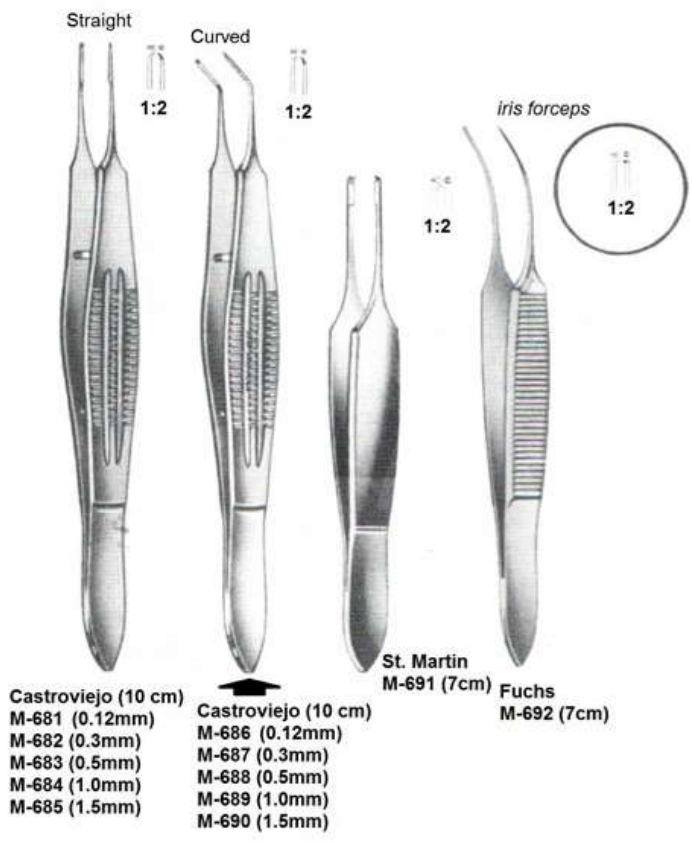

**CAPSULAR FORCEPS**

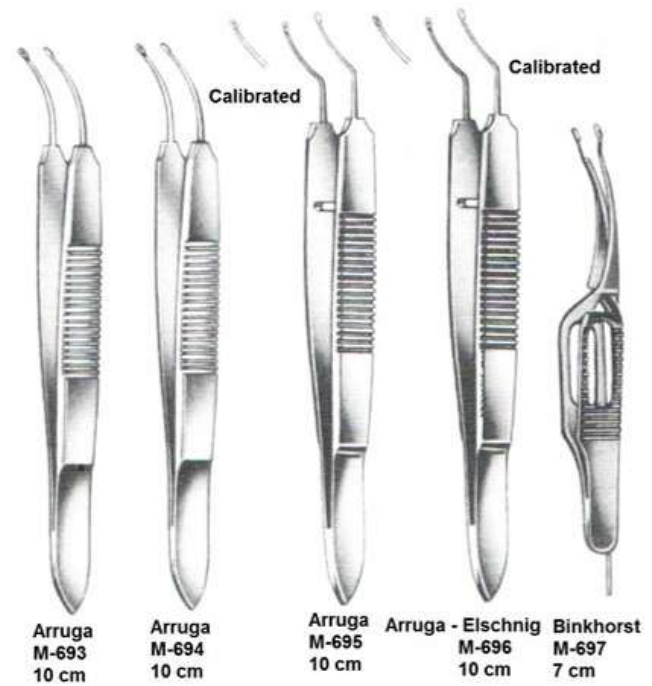

**FIXATION & GRASPING FORCEPS**

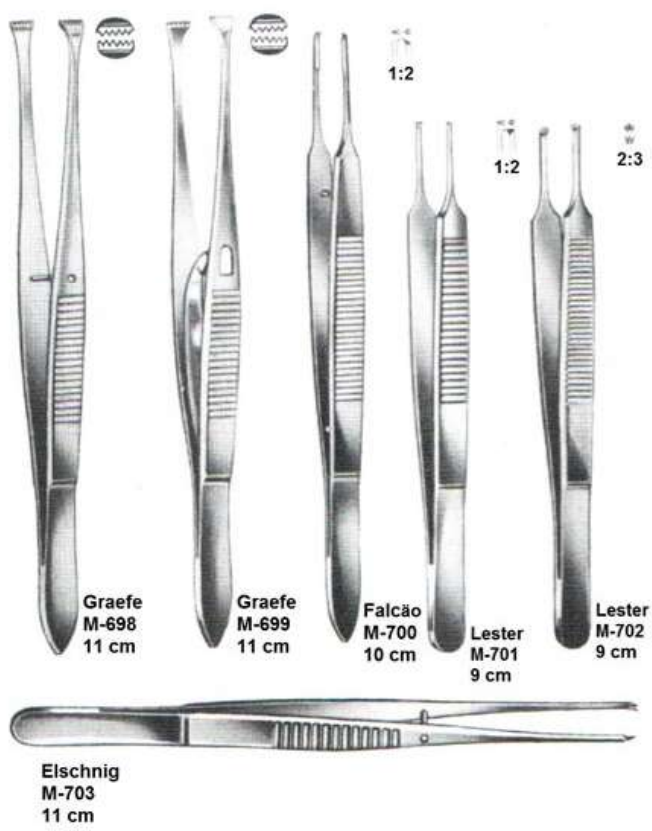

**VARIOUS EYE FORCEPS**

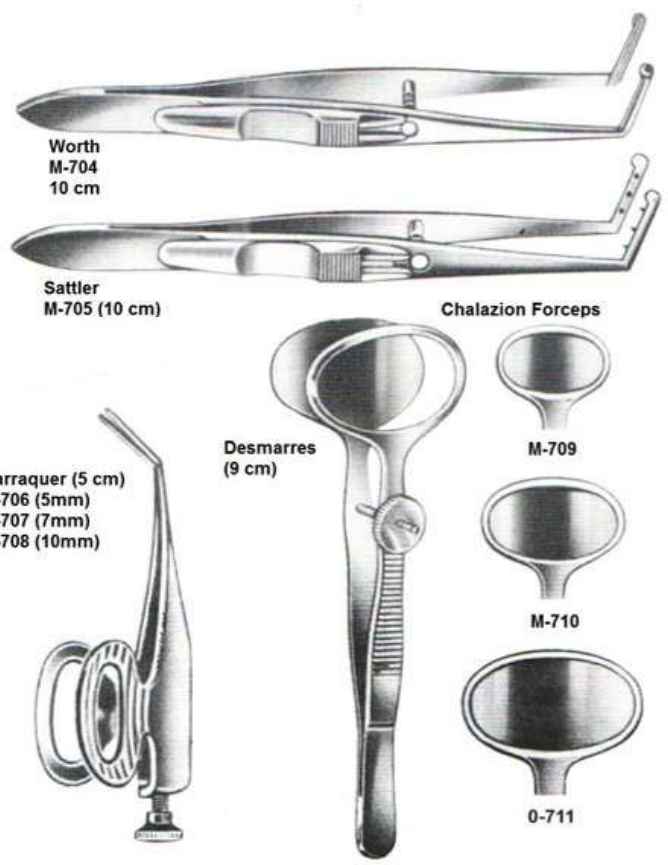



**MICROSCOPIC & EYE SCISSORS**

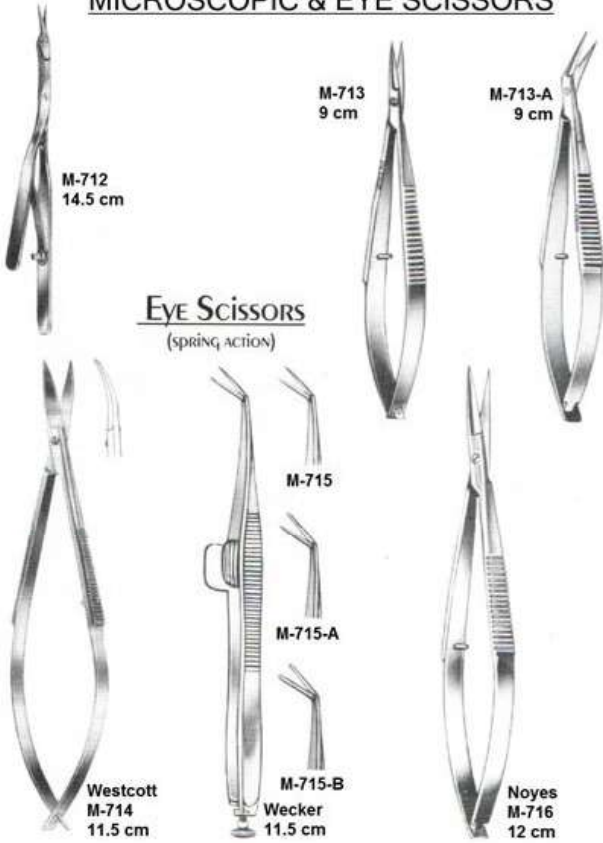

**EYE SCISSORS (Spring Action)**

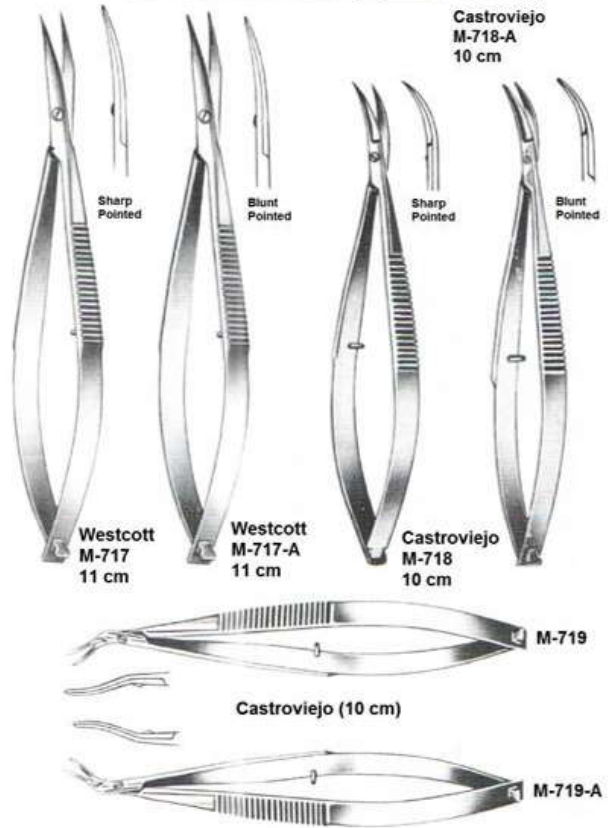

**MICRO SCISSORS (Spring Action)**

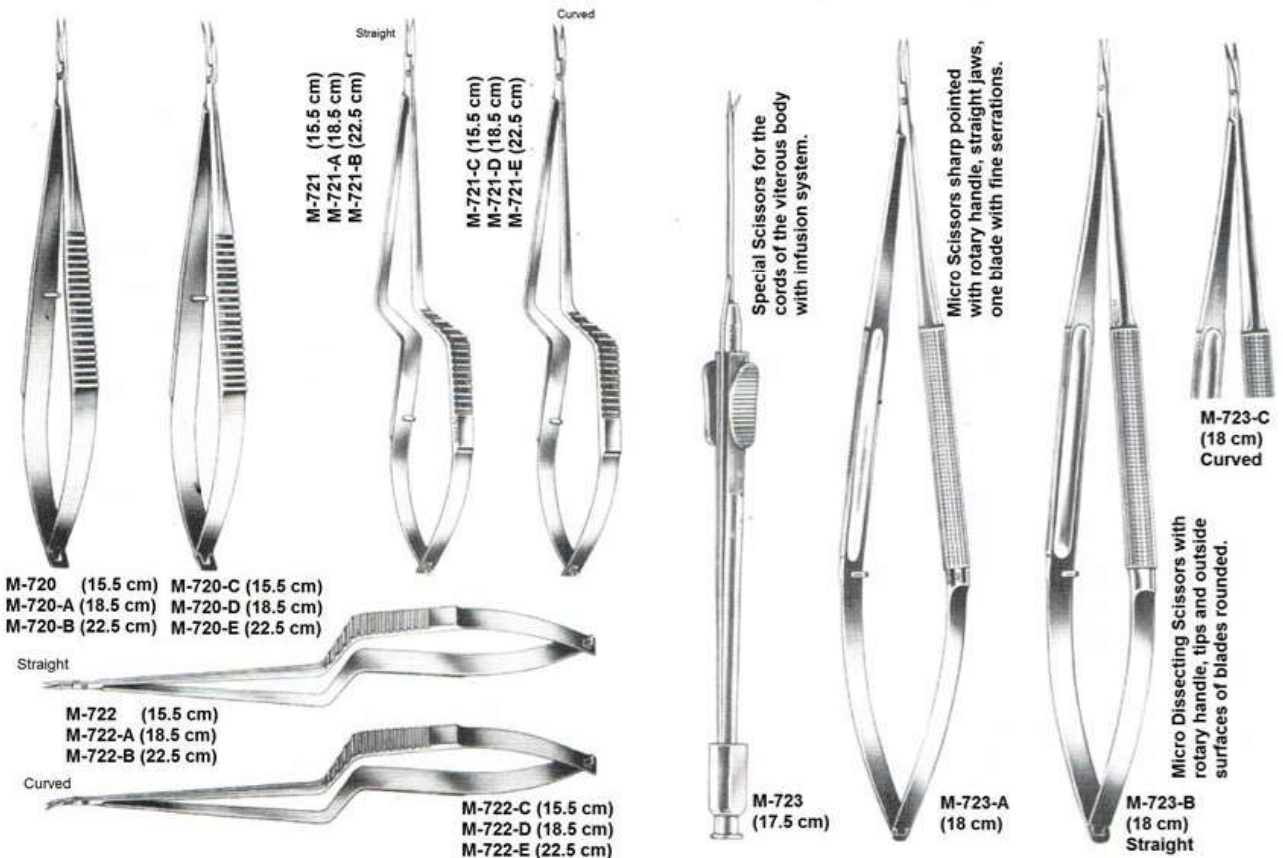

**SUTURE INSTRUMENTS**



**Ochsner  
M-723-D  
(14 cm)**



**Lange  
M-723-E  
(10 cm)**



**Wachenfeldt  
M-723-F  
(12 cm)**



**Childe  
M-723-G  
(18 cm)**



**Michel  
M-723-H  
(12 cm)**



**Wachenfeldt  
M-723-J  
(12.5 cm)**



**Hegenbarth  
M-723-K  
(12.5 cm)**



**Wachenfeldt  
M-723-L  
(12.5 cm)**



**Michel  
M-723-M  
(12 cm)**



**Mod. Michel  
M-723-N  
(12 cm)**

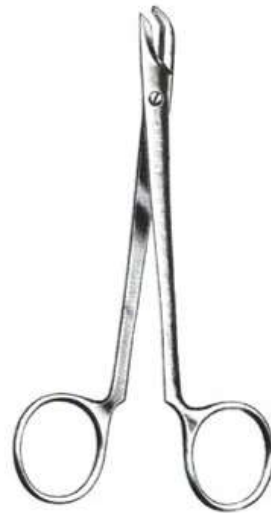

**Collin  
M-723-P  
(13 cm)**



**Richter-Heath  
M-723-R  
(14 cm)**

# ARTERY FORCEPS

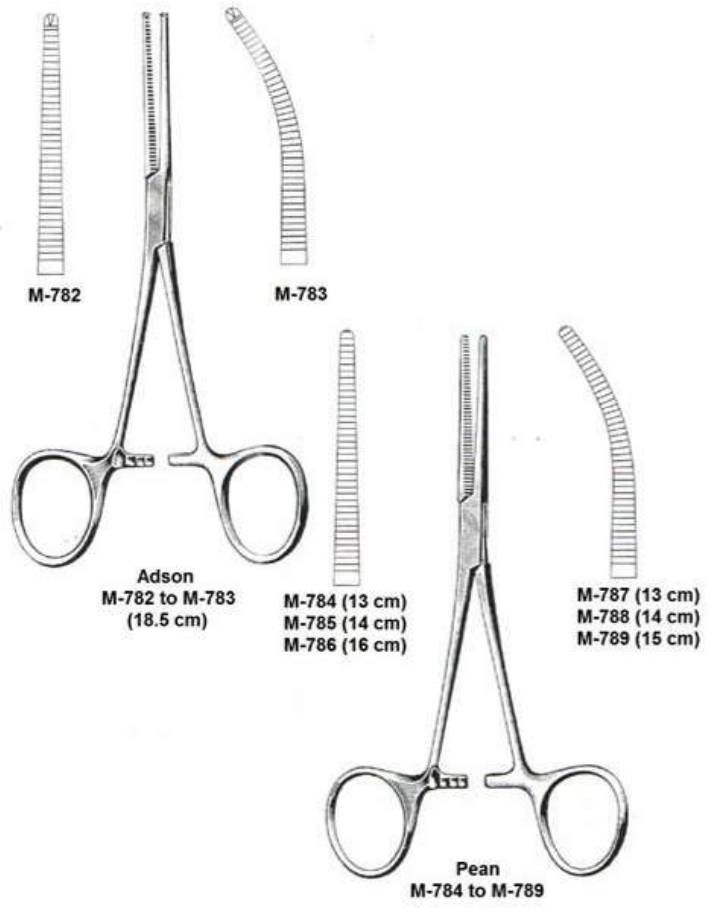
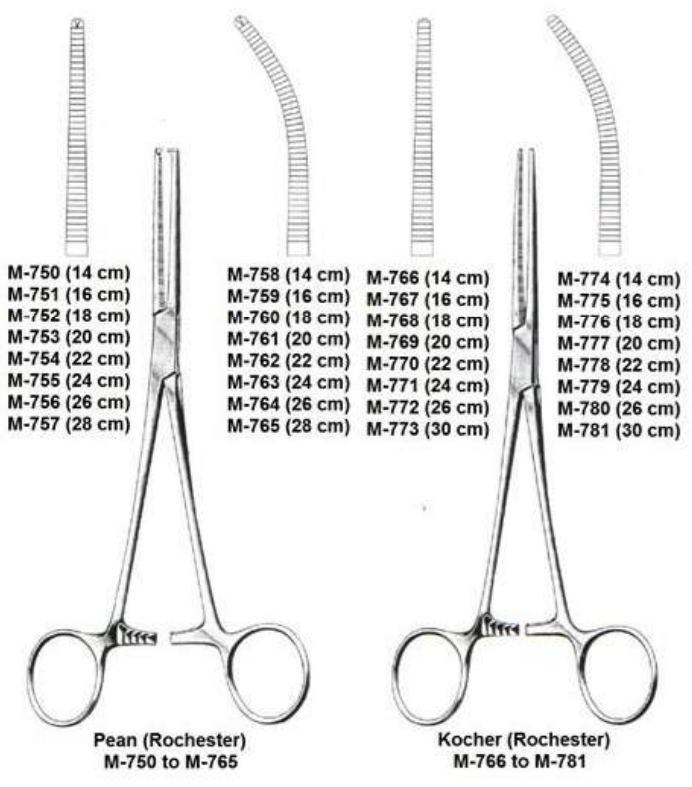
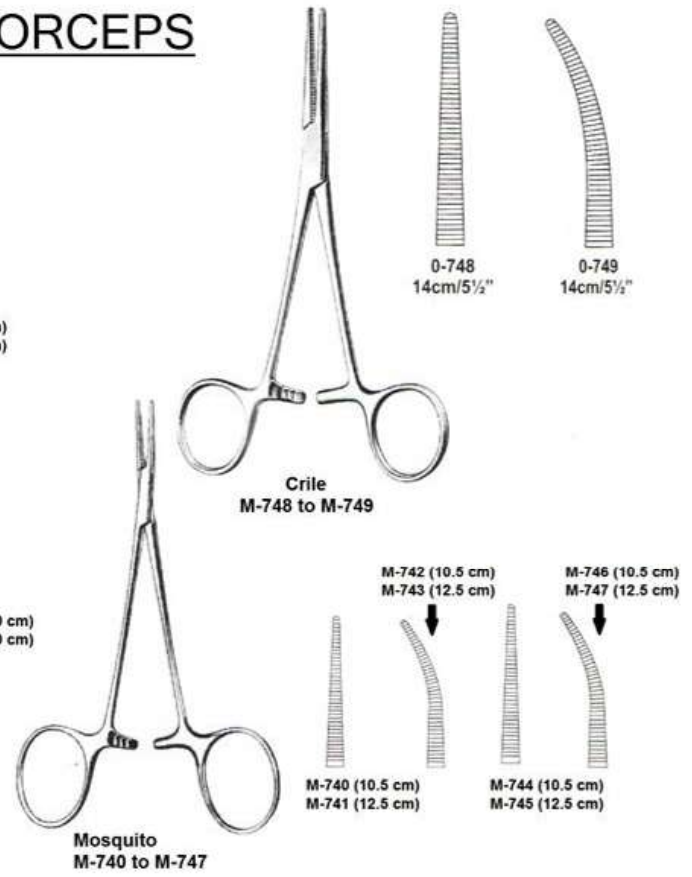
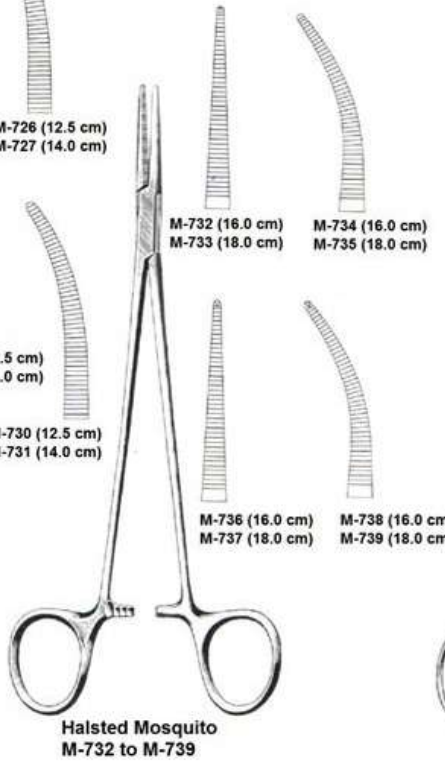
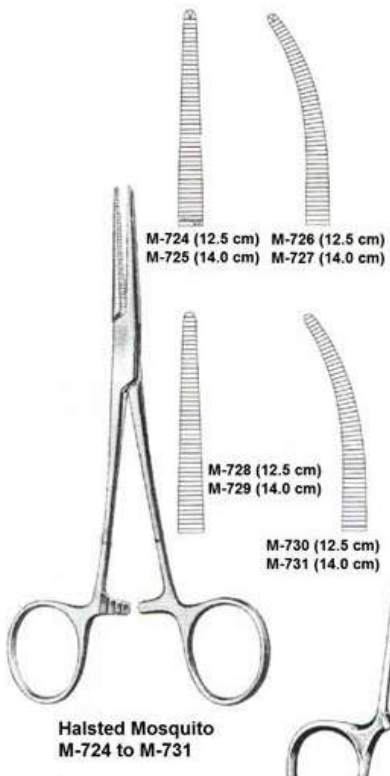

## ARTERY FORCEPS

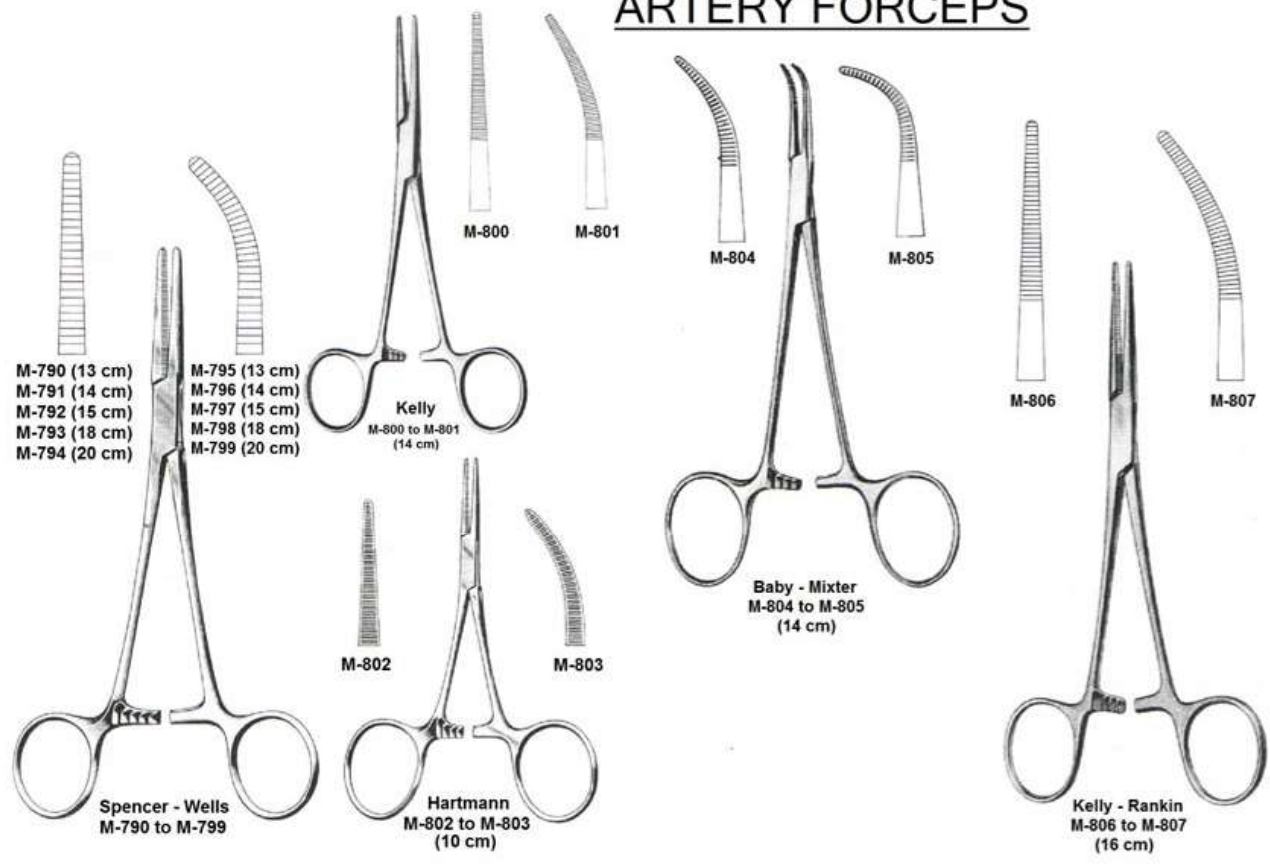

## ARTERY & HYSTERECTOMY FORCEPS

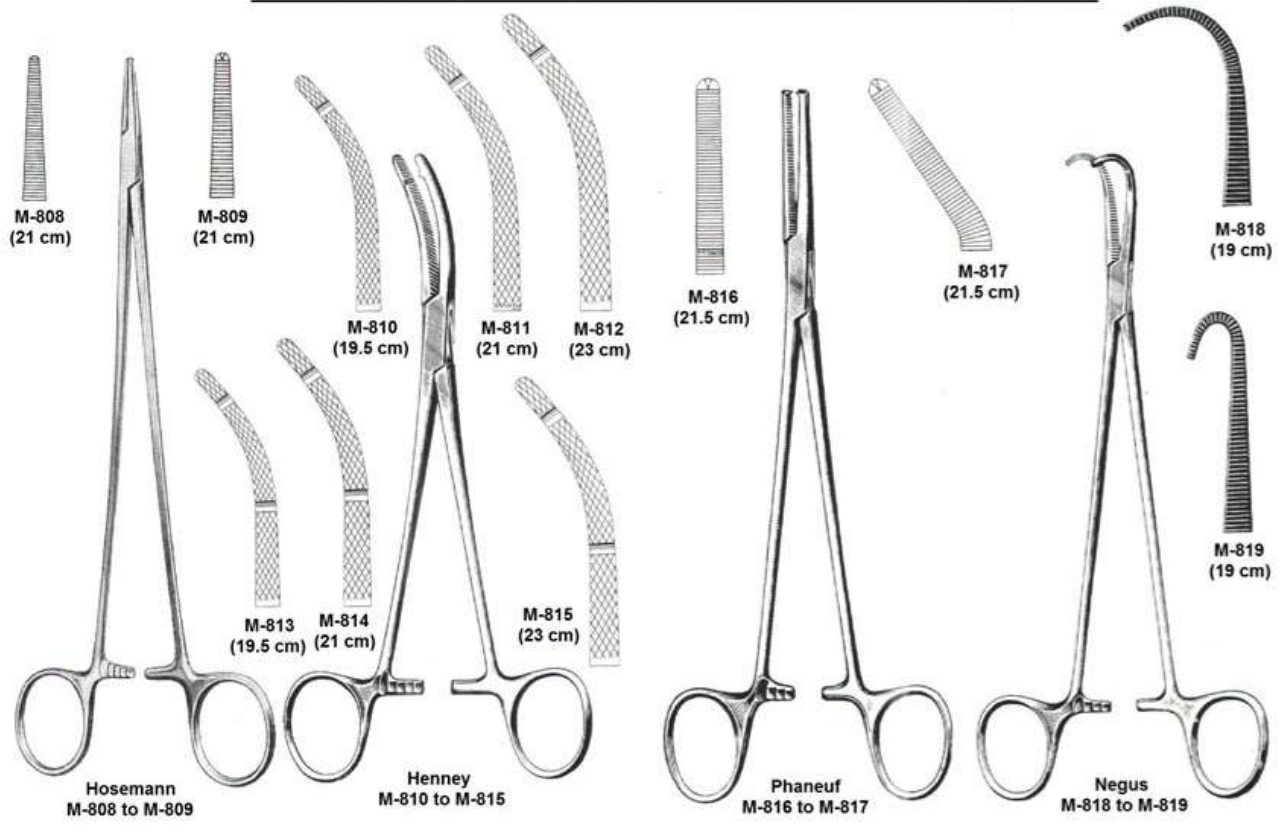

**NEEDLE HOLDERS**

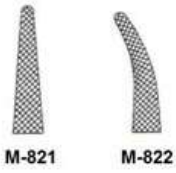

M-821

M-822



Arruga  
M-821 to M-822  
(16 cm)



Castroviejo  
M-820 (13 cm)



Castroviejo  
M-823 to M-824  
(14 cm)

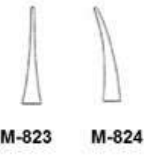

M-823

M-824



Derf  
M-825  
(12 cm)



Collier  
M-826  
(12.5 cm)



Webster  
M-827  
(13 cm)



Crile  
M-828 (15 cm)



Toennis  
M-829 (18 cm)



Stratte  
M-830  
(23 cm)



Olsen - Hegar  
M-831 (14 cm)  
M-832 (16 cm)



Gillies  
M-833 (16 cm)

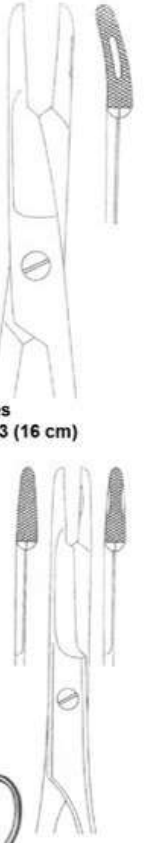

**NEEDLE HOLDERS**



**Halsey  
M-834 (13 cm)**



**Neivart  
M-835 (13 cm)**



**Crile - Murray  
M-839 (15 cm)**



**Crile - Wood  
M-840 (15 cm)**



**Hegar - Baumgartner  
M-836 (14 cm)**

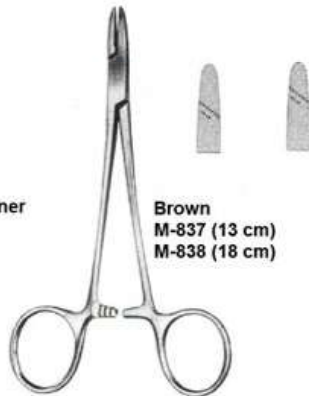

**Brown  
M-837 (13 cm)  
M-838 (18 cm)**



**Adson  
M-841 (18 cm)**

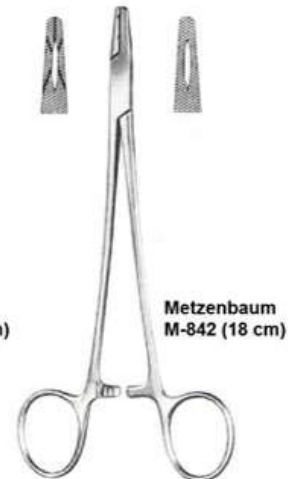

**Metzenbaum  
M-842 (18 cm)**

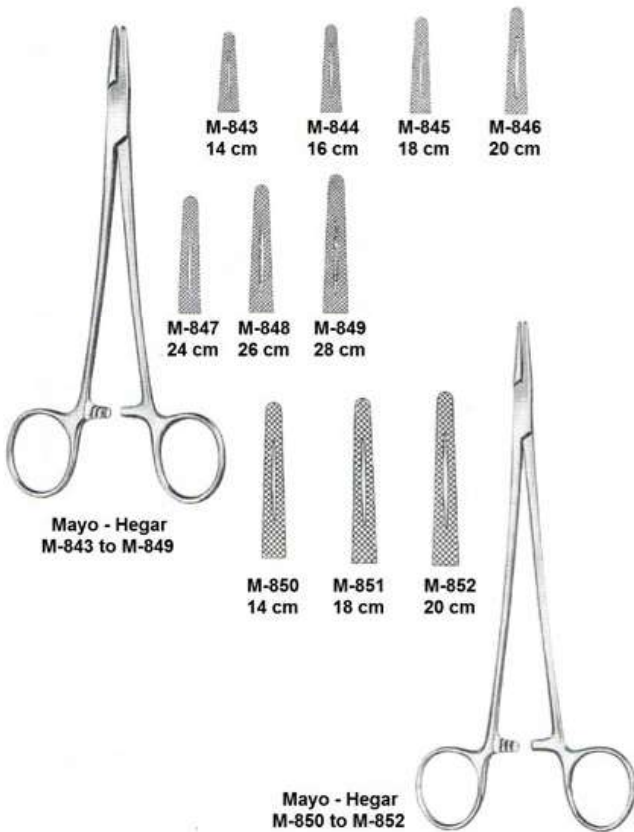

**M-843 14 cm M-844 16 cm M-845 18 cm M-846 20 cm**

**M-847 24 cm M-848 26 cm M-849 28 cm**

**M-850 14 cm M-851 18 cm M-852 20 cm**

**Mayo - Hegar  
M-843 to M-849**

**Mayo - Hegar  
M-850 to M-852**



**Heaney  
M-853  
(21 cm)**

**Jamison  
M-854  
(23 cm)**

**Masson  
M-855  
(27 cm)**

**TOWEL FORCEPS**

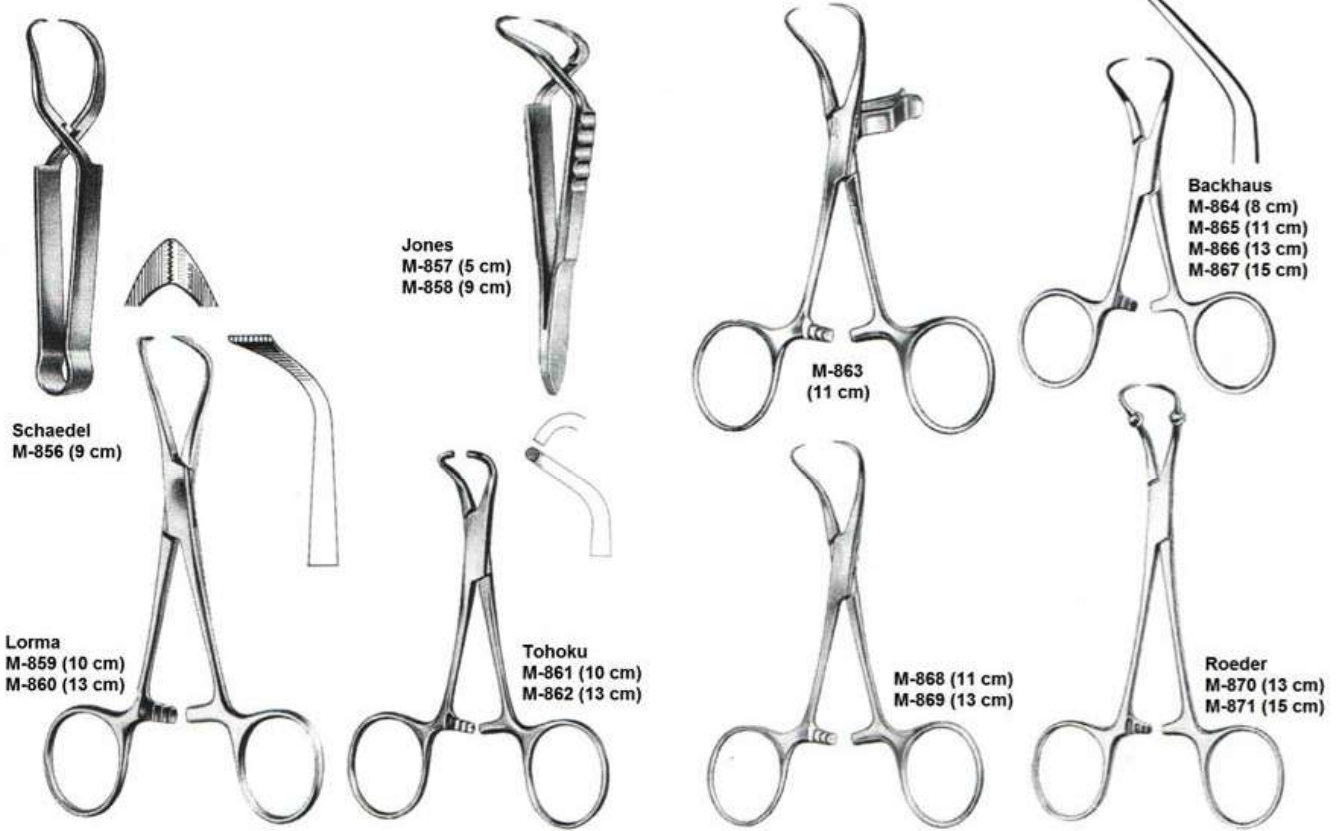

**MICRO NEEDLE HOLDERS**

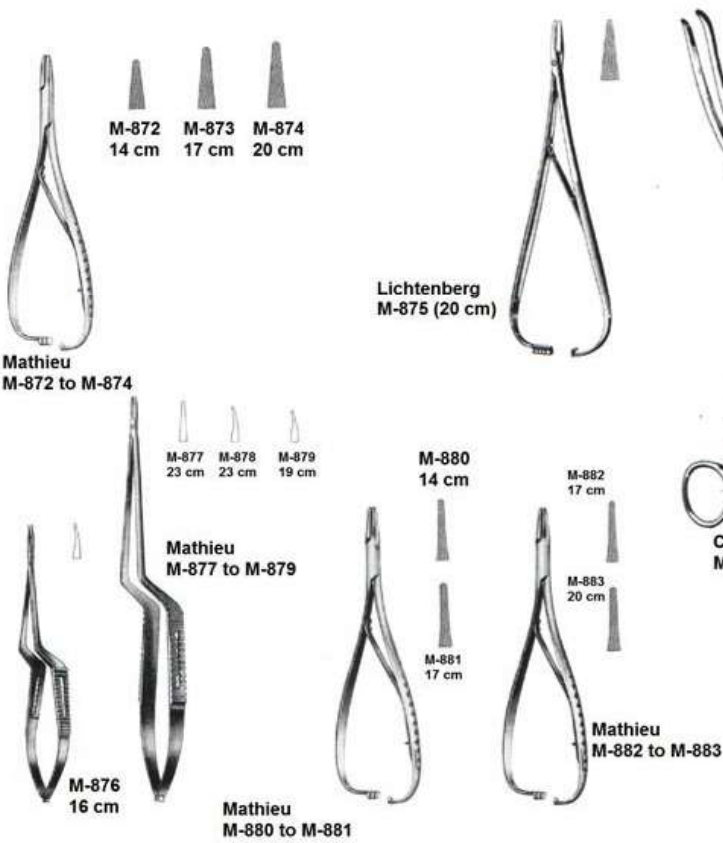

**STERILIZING FORCEPS**

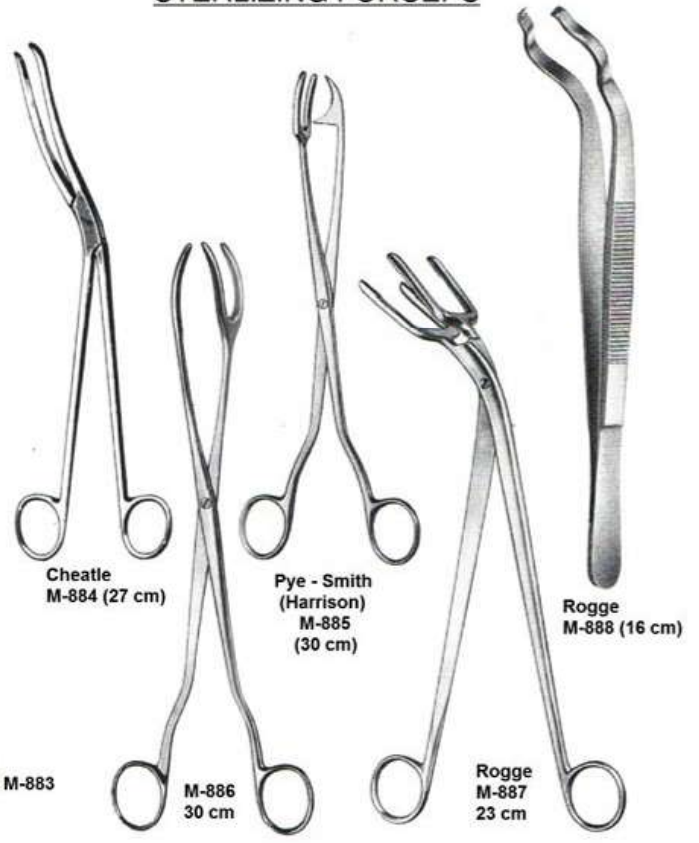

**SPONGE HOLDING FORCEPS**

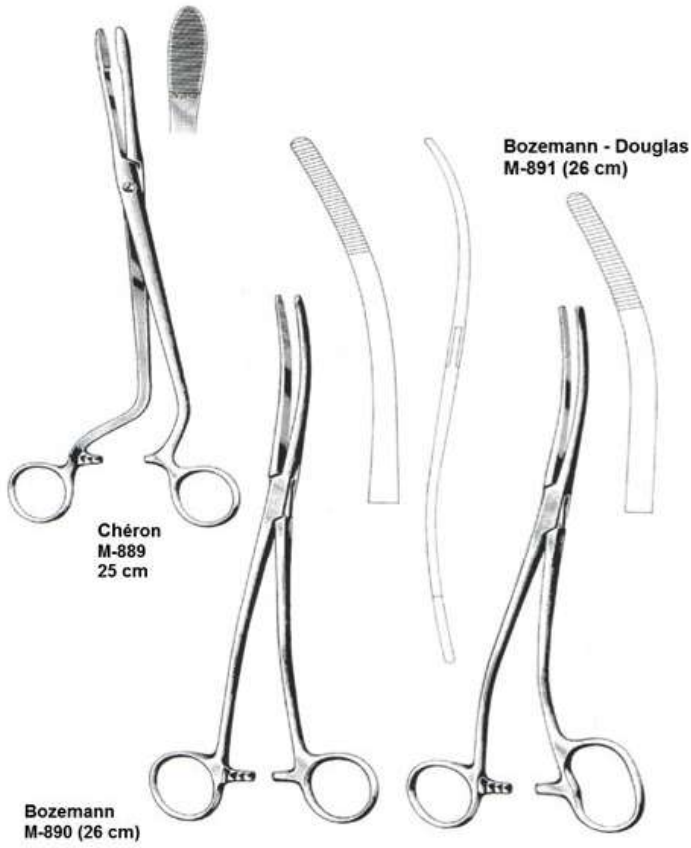

**POLYPUS & SPONGE HOLDING FORCEPS**



**TISSUE & ORGAN HOLDING FORCEPS**

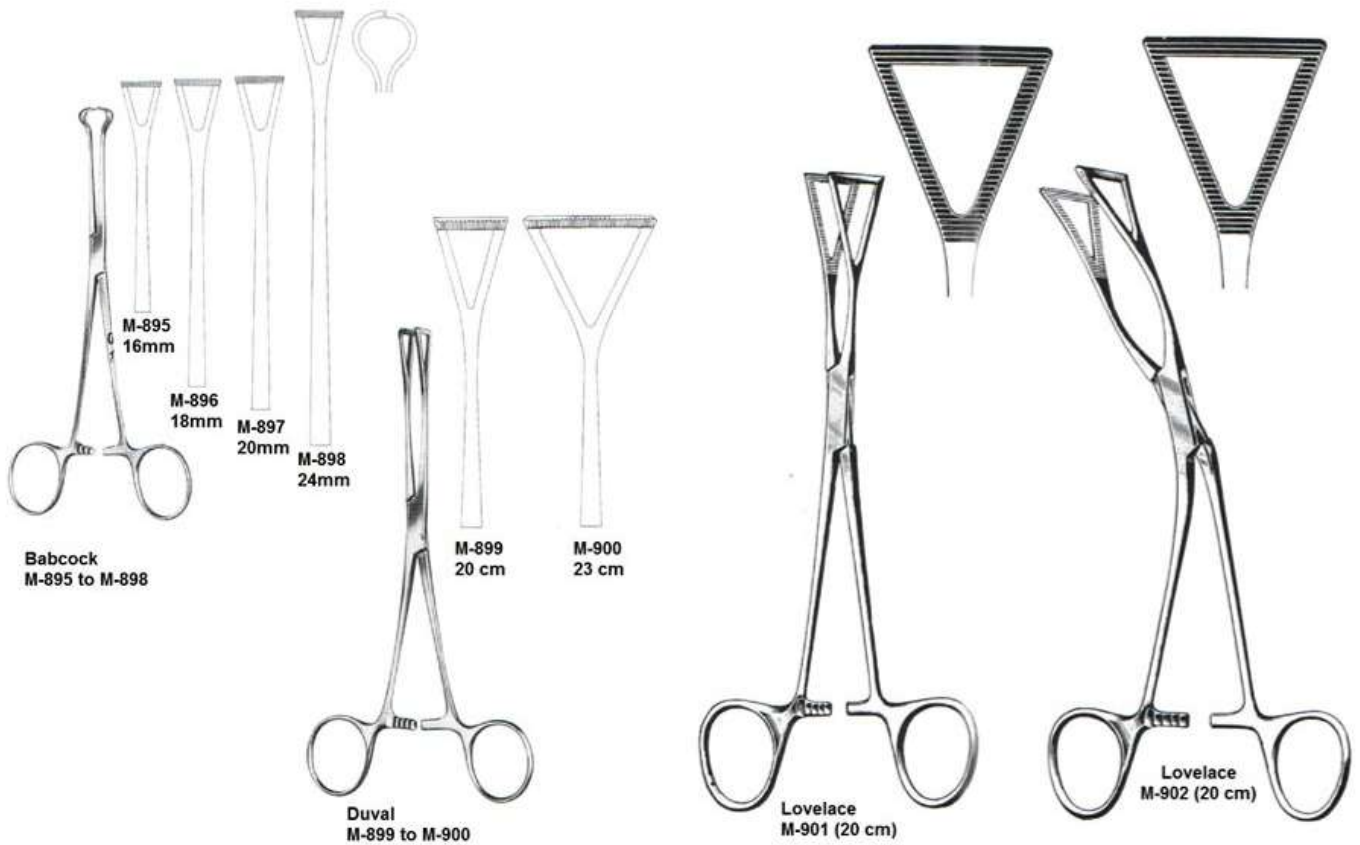



SPONGE HOLDING FORCEPS

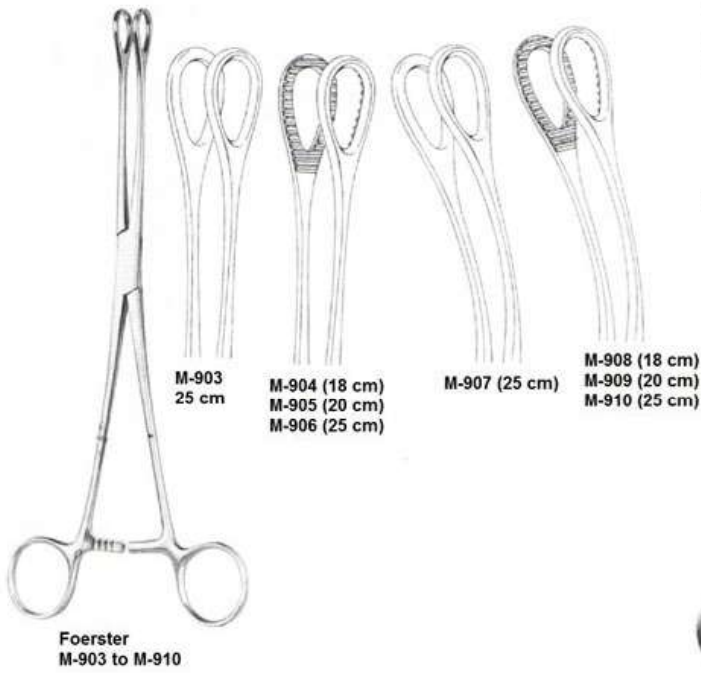

SPONGE & DRESSING FORCEPS

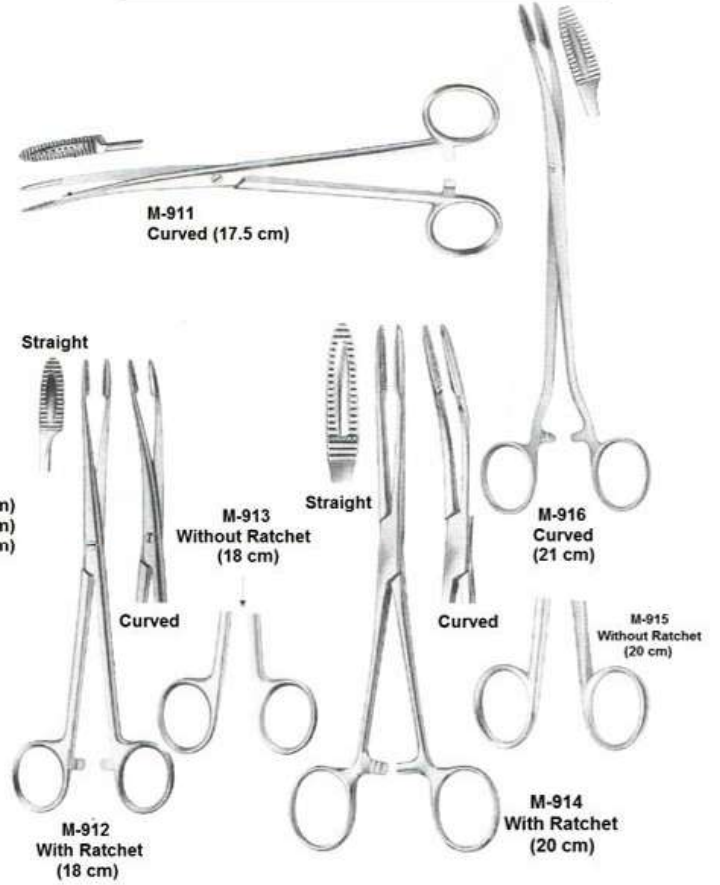

TISSUE & ORGAN HOLDING FORCEPS



TONGUE HOLDING FORCEPS



**TONGUE DEPRESSORS**



Wood  
M-925  
(16 cm)



Wood  
M-926  
(15 cm)



Haas  
M-927 (16 cm)



Buchwald  
M-928 (17 cm)



Martin  
Bolable  
M-929  
(18.5 cm)



Bruenings  
M-930 (19 cm)



Frenzel  
M-931 (16.5 cm)

**MOUTH GAGS**

Denhart  
M-932 (12 cm)

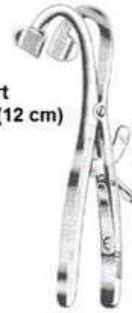

Roser - Konig  
M-933 (16 cm)  
M-934 (20 cm)



Heister  
M-935 (13 cm)



Molt  
M-936  
(11 cm)

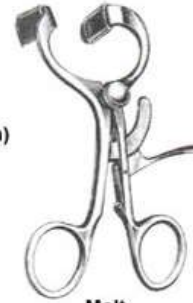

Molt  
M-937  
(14 cm)



31

**CHEEK & LIP RETRACTORS**

Sternberg  
M-938 (14 cm)  
M-939 (16 cm)  
M-940 (18 cm)



M-944  
(14 cm)



M-945  
(15 cm)



Sternberg  
M-941 (12 cm)  
M-942 (14 cm)  
M-943 (16 cm)



Wieder  
M-944 to M-945

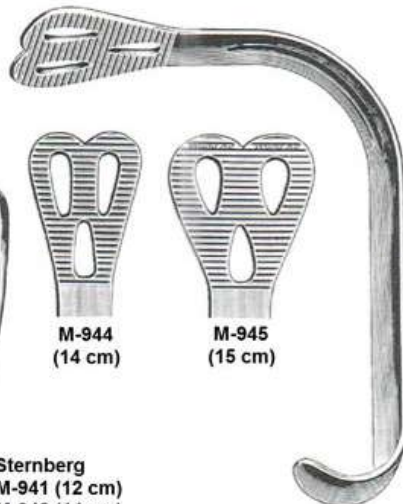

Jennings  
M-946 (9 cm)  
M-947 (11 cm)  
M-948 (13 cm)  
M-949 (15 cm)



**TONGUE DEPRESSORS**

Tobold  
M-953 (14.5 cm)

Tobold  
M-952 (14.5 cm)

Hartmann  
M-951 (15 cm)

Andrew  
M-950 (11 cm)



**LARYNGEAL POLYPUS FORCEPS**

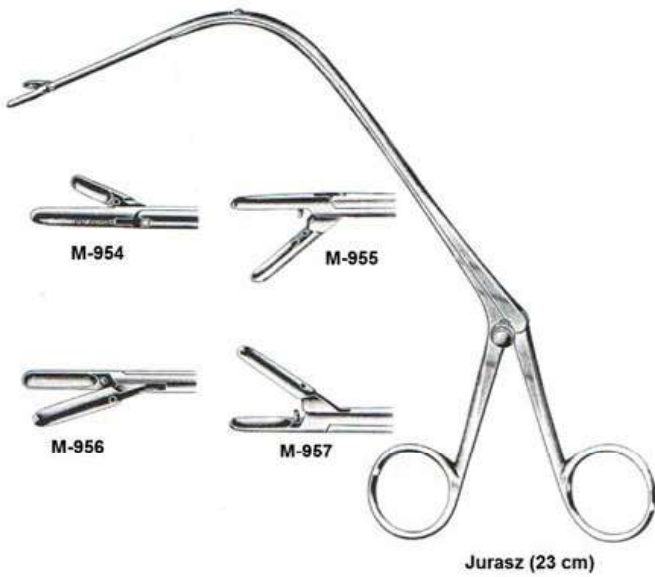

**BRONCHOSCOPIC FORCEPS**



Cm	M-958	M-962	M-966
30	M-958	M-962	M-966
40	M-959	M-963	M-967
50	M-960	M-964	M-968
60	M-961	M-965	M-969

Cm	M-970	M-974	M-978	M-982
30	M-970	M-974	M-978	M-982
40	M-971	M-975	M-979	M-983
50	M-972	M-976	M-980	M-984
60	M-973	M-977	M-981	M-985

**EAR POLYPUS FORCEPS**

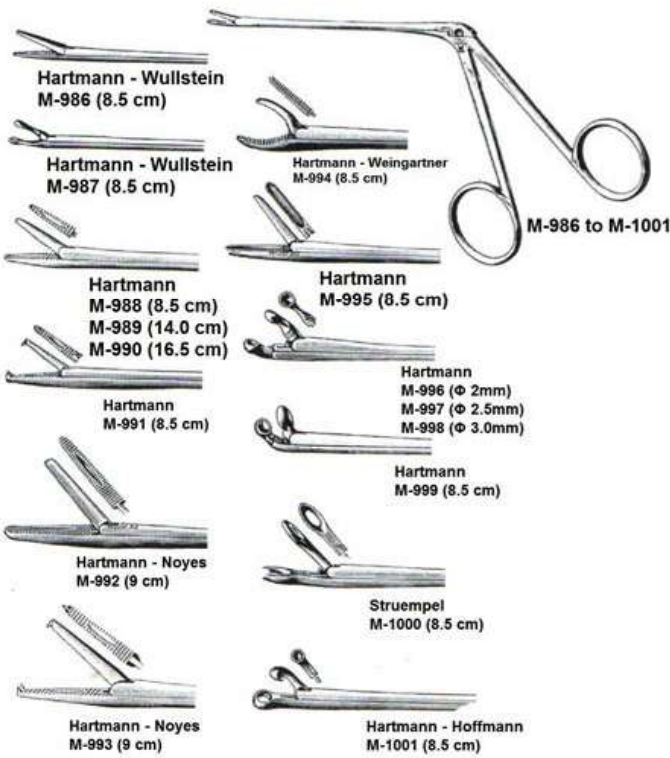

- Hartmann - Wullstein M-986 (8.5 cm)
- Hartmann - Wullstein M-987 (8.5 cm)
- Hartmann M-988 (8.5 cm)
- Hartmann M-989 (14.0 cm)
- Hartmann M-990 (16.5 cm)
- Hartmann M-991 (8.5 cm)
- Hartmann M-992 (9 cm)
- Hartmann M-993 (9 cm)
- Hartmann - Weingartner M-994 (8.5 cm)
- Hartmann M-995 (8.5 cm)
- Hartmann M-996 (Ø 2mm)
- Hartmann M-997 (Ø 2.5mm)
- Hartmann M-998 (Ø 3.0mm)
- Hartmann M-999 (8.5 cm)
- Struempel M-1000 (8.5 cm)
- Hartmann - Hoffmann M-1001 (8.5 cm)

**EAR DRESSING FORCEPS**

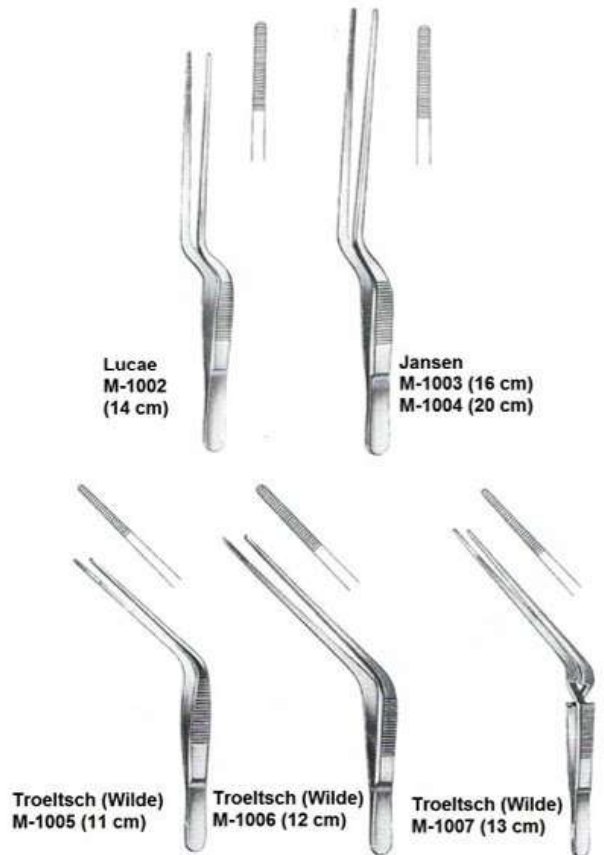

**EAR DRESSING FORCEPS  
EAR POLYPUS SNARES**



**TONSIL SNARES**



**NASAL SPECULA**

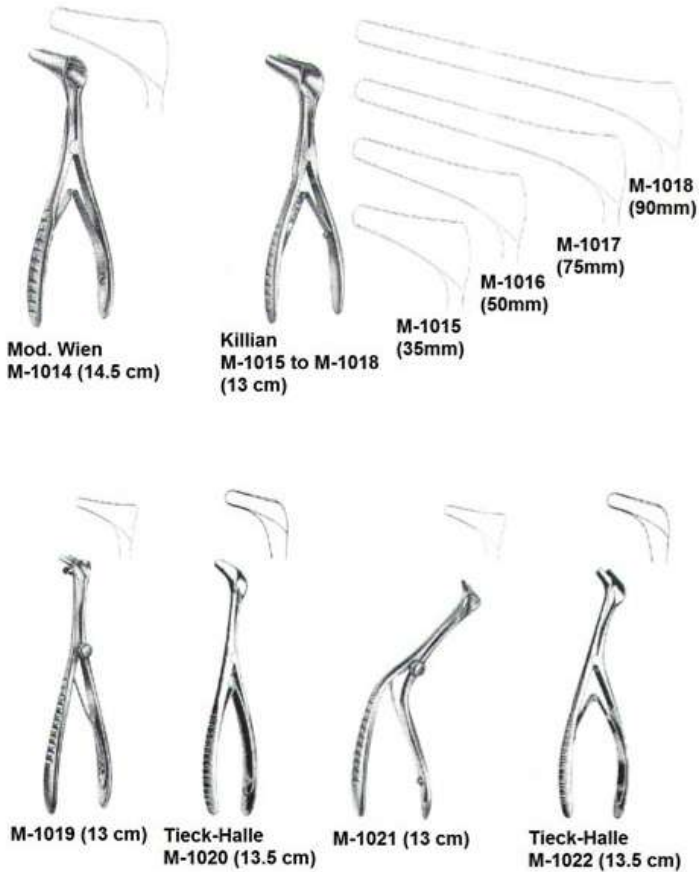

**POLYPUS & FOREIGN BODY FORCEPS**

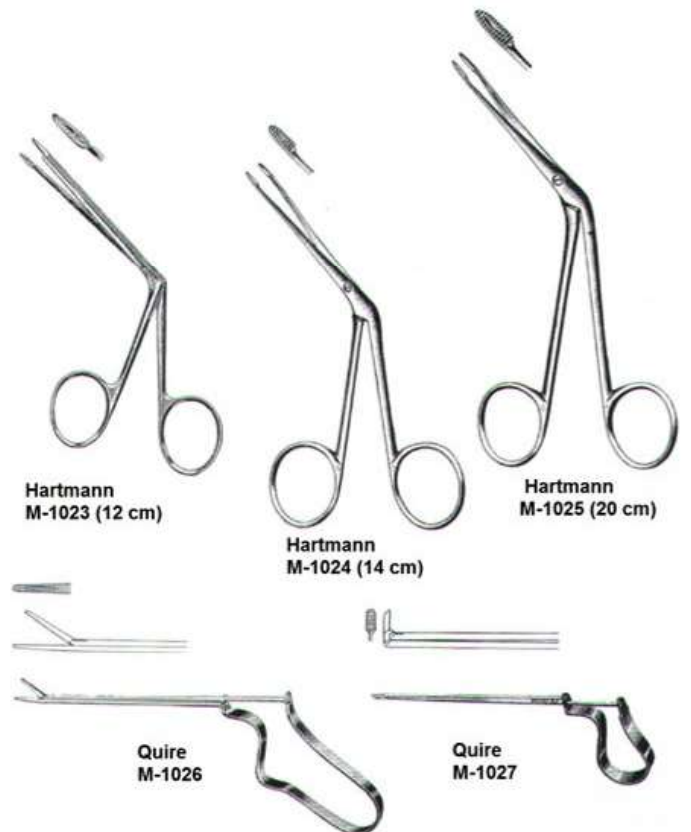

**RHINOPLASTIC INSTRUMENTS**

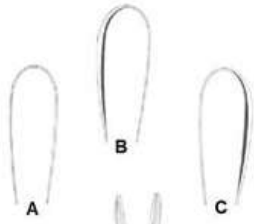

**Cottle - Walsham**  
M-1028 (23 cm)



**Kressner**  
M-1029 (20 cm)



**Asch**  
M-1030 (23 cm)



**Joseph**  
M-1031 (15 cm)



**Cottle**  
M-1032 (16 cm)



**Lange**  
M-1033 (22 cm)

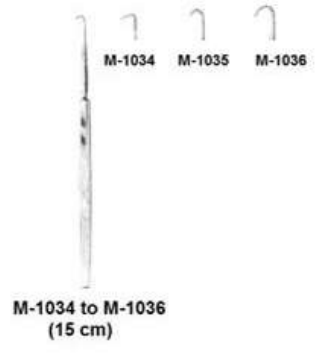

**M-1034 to M-1036**  
(15 cm)



**Kilner**  
M-1037 (10 cm)

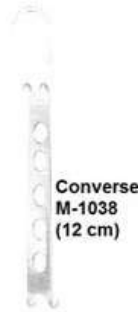

**Converse**  
M-1038 (12 cm)



**Freer**  
M-1039 (15 cm)

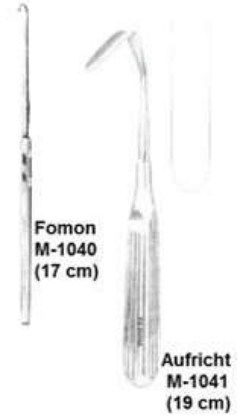

**Fomon**  
M-1040 (17 cm)

**Aufricht**  
M-1041 (19 cm)

**34**

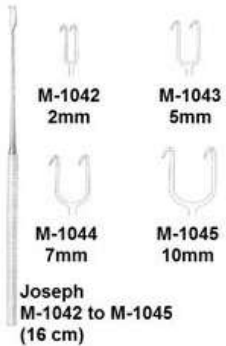

**M-1042**  
2mm

**M-1043**  
5mm

**M-1044**  
7mm

**M-1045**  
10mm

**Joseph**  
M-1042 to M-1045 (16 cm)



**Fomon**  
M-1046 (16 cm)



**Silver**  
M-1054 (18 cm)



**Silver**  
M-1055 (18 cm)



**Silver**  
M-1056 (18 cm)

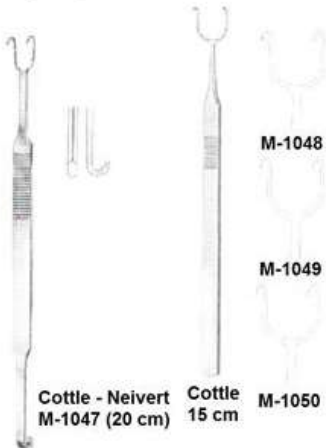

**Cottle - Neivert**  
M-1047 (20 cm)

**Cottle**  
15 cm

**M-1050**

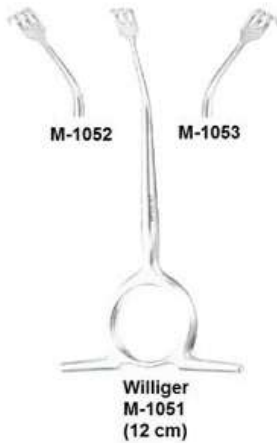

**M-1052**

**M-1053**

**Williger**  
M-1051 (12 cm)

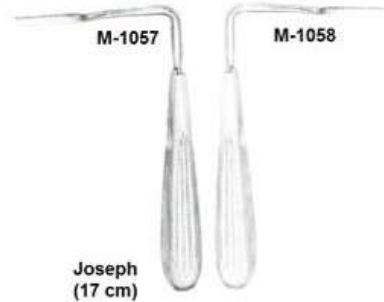

**M-1057**

**M-1058**

**Joseph**  
(17 cm)

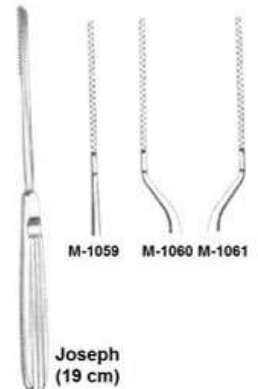

**M-1059**

**M-1060**

**M-1061**

**Joseph**  
(19 cm)

**VAGINAL SPECULA**

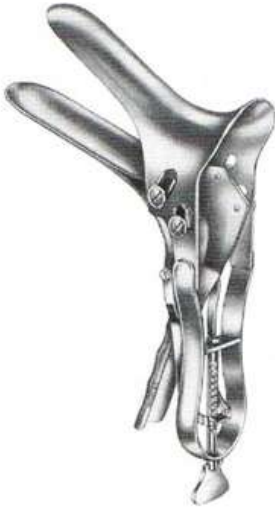

**Seyffert**  
M-1062 (100 X 17mm)  
M-1063 (110 X 33mm)



**Seyffert**  
M-1064 (110 X 33mm)



**Pederson**  
M-1065 (75 X 13mm)  
M-1066 (100 X 22mm)  
M-1067 (120 X 25mm)



**Grave**  
M-1068 (75 X 20mm)  
M-1069 (95 X 35mm)  
M-1070 (115 X 35mm)



**Semm**  
M-1071 (100 X 17/20mm)  
M-1072 (100 X 25/30mm)



**Fergusson**  
M-1073 (Φ 25mm)  
M-1074 (Φ 30mm)  
M-1075 (Φ 35mm)



**Collin**  
M-1076 (55 X 10mm)  
*for children*

**Swiss Pattern**



**Cusco**  
M-1082 (80 X 22mm)  
M-1083 (100 X 25mm)  
M-1084 (105 X 27mm)

**Cusco**  
M-1085 (75 X 32mm)  
M-1086 (85 X 35mm)  
M-1087 (100 X 37mm)



**Cusco**  
M-1077 (75 X 32mm)  
M-1078 (85 X 35mm)  
M-1079 (100 X 35mm)  
M-1080 (85 X 35mm)



**Cusco**  
M-1081 (75 X 17mm)



**Collin**  
M-1088 (65 X 20mm)



**Collin**  
M-1089 (85 X 30mm)  
M-1090 (100 X 35mm)  
M-1091 (110 X 40mm)  
M-1092 (100 X 35mm)



**Collin - Landau**  
M-1093 (100 X 35mm)



**Trélat**  
M-1094 (85 X 33mm)  
M-1095 (95 X 35mm)  
M-1096 (115 X 43mm)

VAGINAL SPECULA

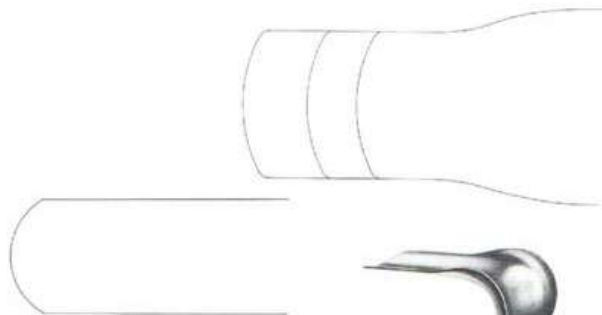

	mm	mm
M-1119	75	45
M-1120	90	45
M-1121	110	45

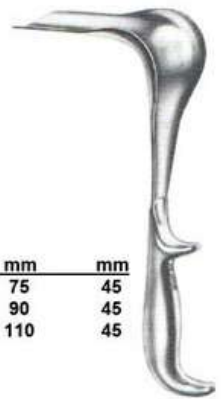

Doyen M-1119 to M-1121

Slightly Concave	mm	mm
M-1108	55	35
M-1109	58	35
M-1110	115	35
M-1111	55	45
M-1112	55	45
M-1113	115	45
M-1114	160	45
M-1115	55	60
M-1116	85	60
M-1117	115	60
M-1118	160	60

VAGINAL SPECULA & RETRACTORS



## VAGINAL SPECULA & RETRACTORS

**Sims**  
**M-1127**  
 65 X 25mm  
 70 X 30mm  
**M-1128**  
 70 X 30mm  
 70 X 35mm  
**M-1129**  
 85 X 35mm  
 90 X 40mm



**Jackson**  
**M-1130**  
 75 X 35mm  
**M-1131**  
 90 X 35mm  
**M-1132**  
 100 X 35mm  
**M-1134**  
 90 X 40mm  
**M-1135**  
 100 X 40mm



**Kristeller (Specula)**  
**M-1144**  
 70 X 27mm  
**M-1145**  
 80 X 30mm  
**M-1146**  
 90 X 36mm

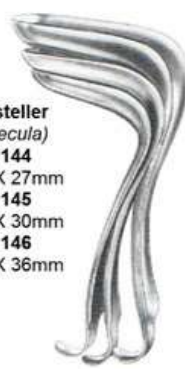

**Kristeller (Retractors)**  
**M-1147**  
 75 X 23mm  
**M-1148**  
 85 X 26mm  
**M-1149**  
 100 X 32mm

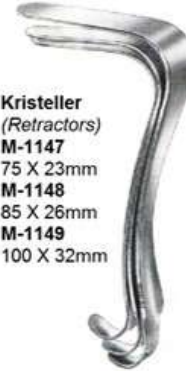

**Kristeller (Set of 1 Speculum & 1 Retractor)**  
**M-1150**  
**M-1151**  
**M-1152**



With Conically Shaped Blades, Virgin Sizes

**Kallmorgen (Vaginal Specula)**  
**M-1136**  
 70 X 40mm  
**M-1137**  
 90 X 40mm



**(Vaginal Retractors)**  
**M-1138**  
 70 X 33mm  
**M-1139**  
 90 X 33mm



**Mathieu (Vaginal Specula)**  
**M-1140**  
 95 X 16mm  
**M-1141**  
 95 X 16mm  
 95 X 30mm

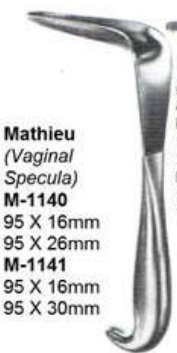

**(Vaginal Retractors)**  
**M-1142**  
 100 X 11mm  
 100 X 20mm  
**M-1143**  
 100 X 14mm  
 100 X 26mm

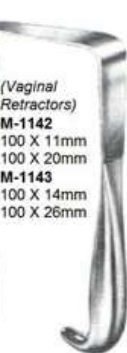

**Kristeller (Specula)**  
**M-1153**  
 105 X 18mm  
**M-1154**  
 105 X 21mm



**Kristeller (Retractors)**  
**M-1155**  
 110 X 14mm  
**M-1156**  
 110 X 17mm



**Kristeller (Set of 1 Speculum & 1 Retractor each)**  
**M-1157**  
**M-1158**



Specula Flat Hollow

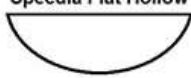

Specula Deep Hollow



**Kristeller (Specula)**  
**M-1167**  
 110 X 27mm  
**M-1168**  
 110 X 30mm  
**M-1169**  
 110 X 36mm



**Kristeller (Retractors)**  
**M-1170**  
 115 X 23mm  
**M-1171**  
 115 X 26mm  
**M-1172**  
 115 X 32mm



**Kristeller (Set of 1 Speculum & 1 Retractor)**  
**M-1173**  
**M-1174**  
**M-1175**



**(Specula)**  
**M-1159**  
 105 X 26mm  
**M-1160**  
 105 X 28mm  
**M-1161**  
 105 X 33mm

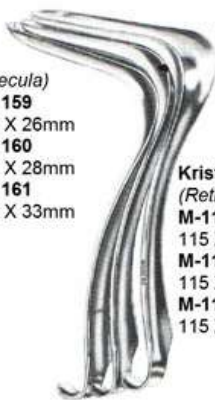

**Kristeller (Retractors)**  
**M-1162**  
 115 X 22mm  
**M-1163**  
 115 X 24mm  
**M-1164**  
 115 X 29mm



**Kristeller (Set of 1 Speculum & 1 Retractor each)**  
**M-1165**  
**M-1166**





**RETRACTORS**

70 X 25mm



**Kocher  
M-1176  
(22.5 cm)**

50 X 85mm



**Doyen  
M-1177  
(25 cm)**

80 X 45mm



**Kocher  
M-1178 to M-1180  
(25 cm)  
M-1178 (80 X 45mm)  
M-1179 (80 X 55mm)  
M-1180 (80 X 65mm)**

**PROSTATIC RETRACTORS**



**Young  
M-1181  
(21 cm)**

**Young  
M-1182  
(22 cm)**

**Young  
M-1183  
(21 cm)**

**Young  
M-1184  
(22 cm)**

**VAGINAL SPECULUM RETRACTORS**

**O'Sullivan - O'Connor  
M-1186**

Vaginal speculum for examination and operative work, self retaining & adjustable frame, lockite ratchet, 2 mobile lateral blades and 3 interchangeable blades (Fig. 1, 2 & 3)

70 X 30mm

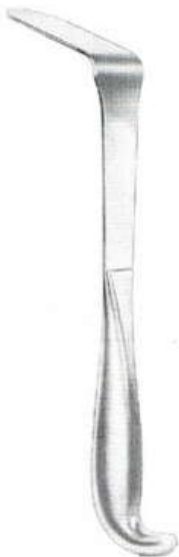

**Doyen  
M-1185  
(24 cm)**

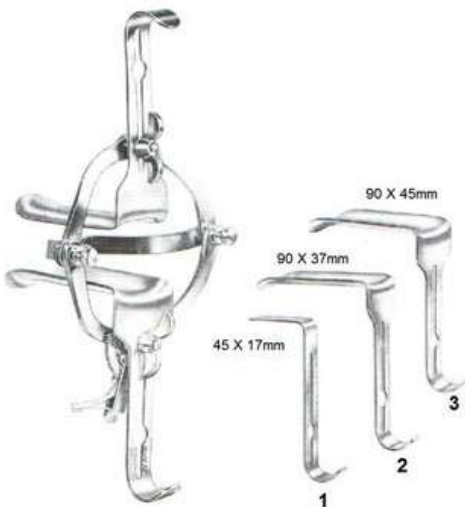

90 X 45mm  
90 X 37mm  
45 X 17mm  
1  
2  
3

- M-1187 (100 X 20mm)
- M-1188 (100 X 25mm)
- M-1189 (100 X 30mm)
- M-1190 (100 X 35mm)
- M-1191 (100 X 40mm)
- M-1192 (130 X 20mm)
- M-1193 (130 X 25mm)
- M-1194 (130 X 30mm)
- M-1195 (130 X 35mm)
- M-1196 (130 X 40mm)
- M-1197 (150 X 40mm)



**Breisky  
M-1187 to M-1197**



**Landau  
M-1198 to M-1199**



**Dunkel  
M-1200**

ANAL RETRACTORS, RECTAL SPECULA, SPHINCTEROSCOPES, ANOSCOPE, PROCTOSCOPES

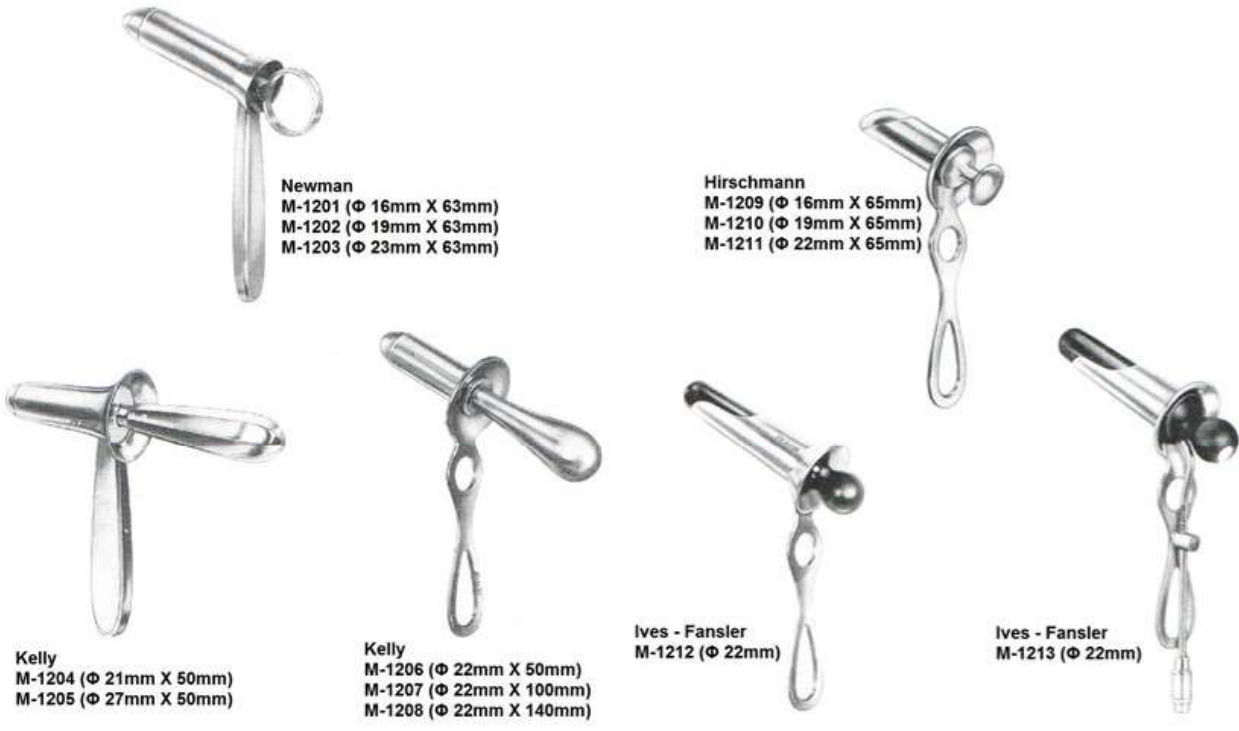

RETRACTORS

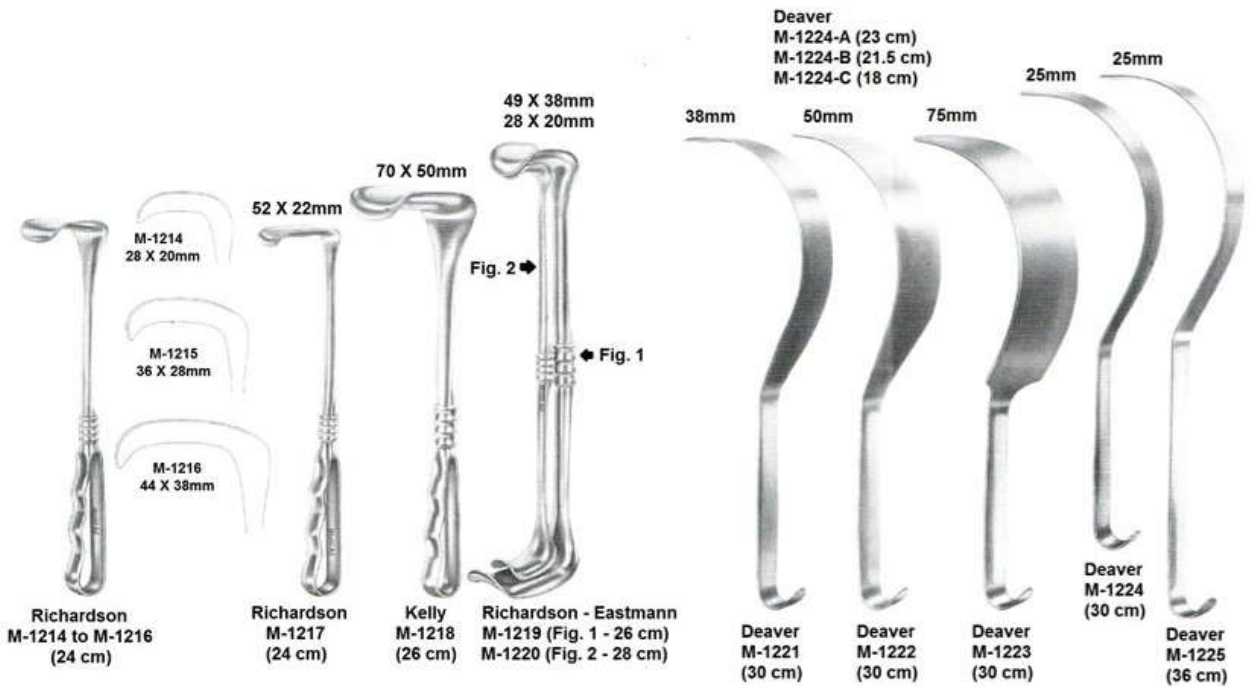

**RETRACTORS**

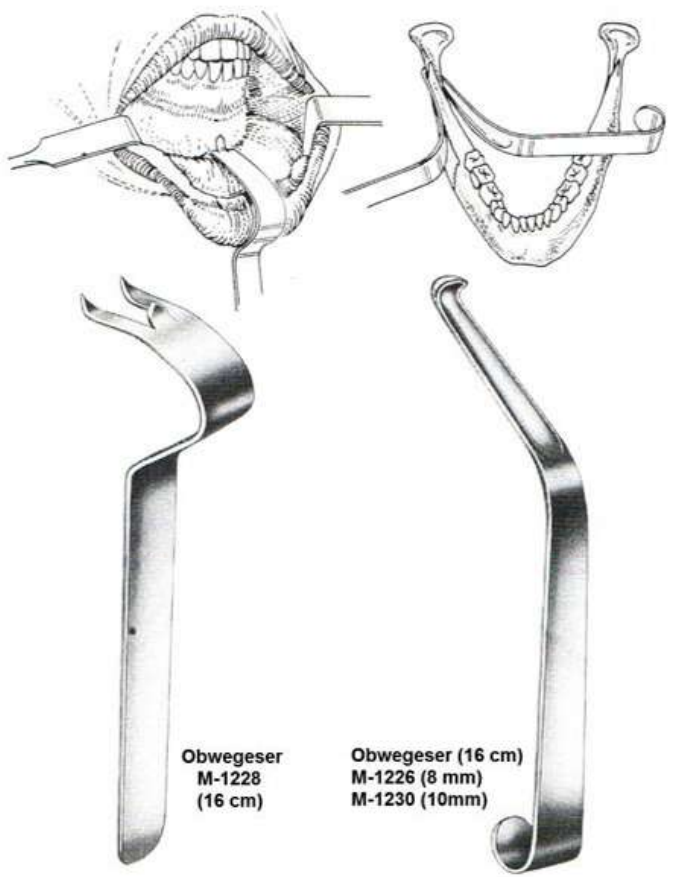
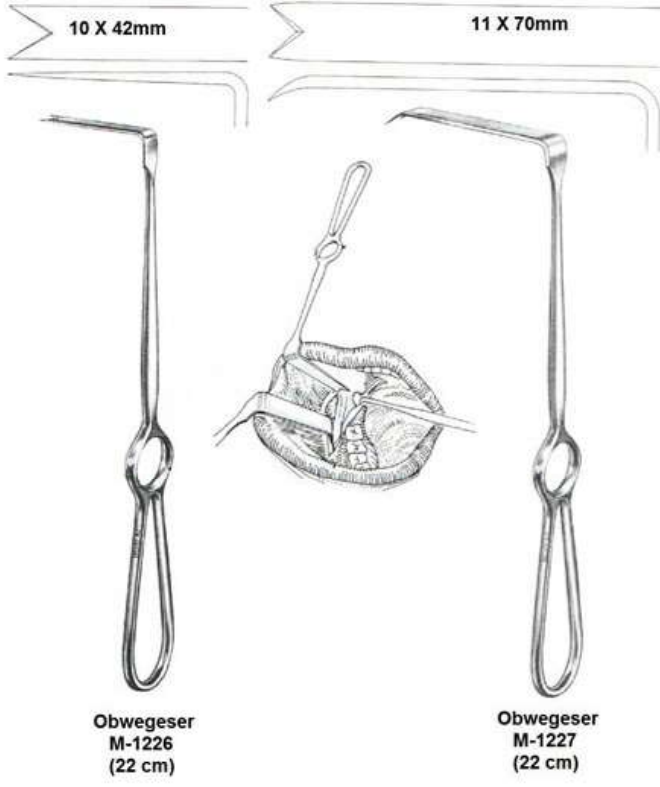

**RHINOPLASTIC INSTRUMENTS**

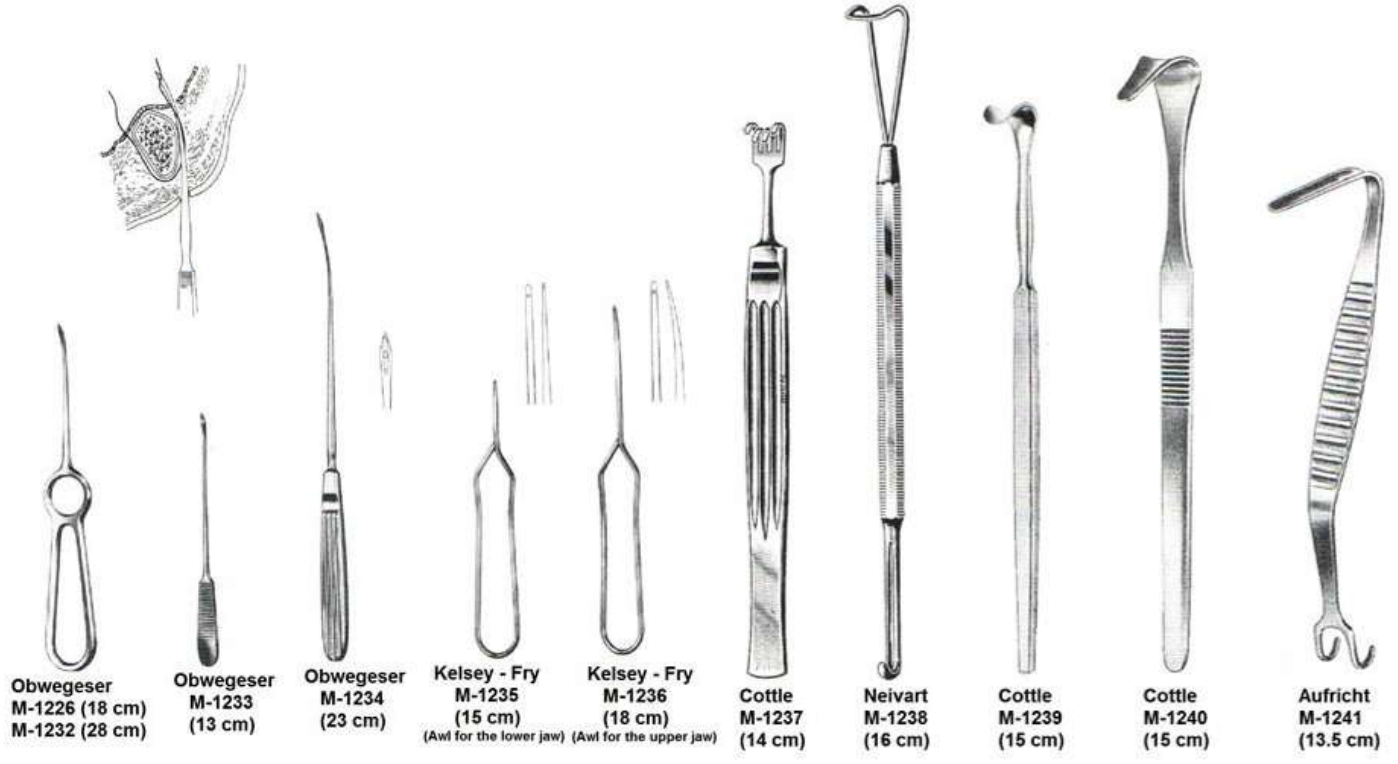

# RECTAL SPECULA, ANAL RETRACTORS

With 2 pair of blades & eenter blades



**Barr**  
M-1242  
(17 cm)



**Alan Parks**  
M-1243  
(13.5 cm)



**Czerny**  
M-1244  
(22 cm)

**Sims**  
M-1245  
(15 cm)

**Sims**  
M-1246  
(15 cm)

**Sims**  
M-1247  
(15 cm)

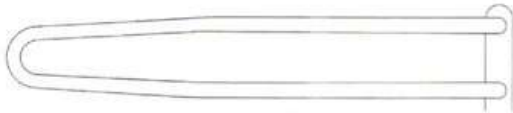

**M-1248**  
Length of Blades 125mm



**Schulze - Bergmann**  
M-1248 to M-1250  
(22 cm)



**M-1249**  
Length of Blades 80mm

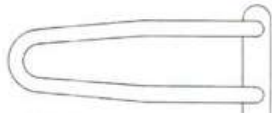

**M-1250**  
Length of Blades 60mm

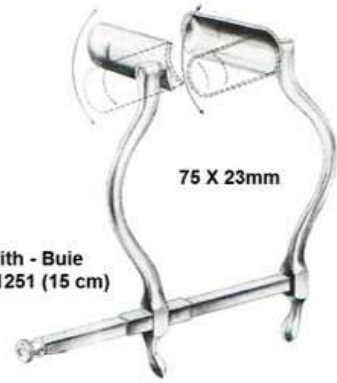

**Smith - Buie**  
M-1251 (15 cm)



**Mathieu**  
M-1252  
(19.5 cm)

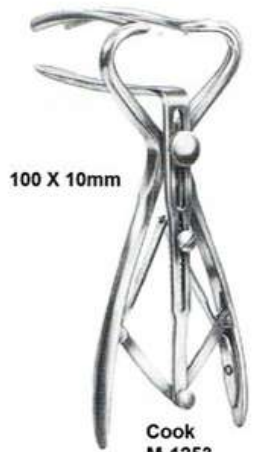

**Cook**  
M-1253  
(19 cm)

**BLADDER RETRACTORS**

2 Valves, Blades (Valves 57mm X 25mm)  
 2 Valves, Blades (Valves 80mm X 25mm)  
 1 Valve, Blade (Valve 120mm X 45mm)



**Judd - Masson  
M-1254**



**Millin  
M-1255**



**Thomson-Walker  
M-1256**



**Legueu  
M-1257**

**RIB SPREADERS**



**M-1258  
Thoracic Retractor (Mercedes-Retractor) Complete  
Consisting of :  
Retractor Only  
1 Pair of Blades 42 X 65mm  
1 Pair of Blades 75 X 75mm**



**BLADDER RETRACTORS**



**Lengueu  
M-1259  
(27 cm)**



**Kocher  
M-1260  
(26 cm)**

# RIB SPREADERS (ALUMINIUM)

**Burford**  
(for children)

with 2 pair of blades

M-1261	a	b	c
	48mm	42mm	135mm
	34mm	42mm	135mm

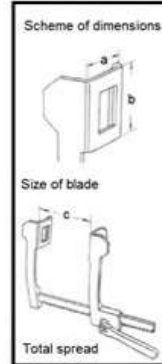

for babies

**Finocchietto - Infant**

M-1265  $\frac{a \quad b \quad c}{15mm \quad 15mm \quad 75mm}$

Child Size

**Finocchietto-Baby-Haight**

M-1266  $\frac{a \quad b \quad c}{31mm \quad 31mm \quad 100mm}$

**Burford**  
(for adults)

with 2 pair of blades

M-1262	a	b	c
	65mm	62mm	180mm
	47mm	62mm	180mm
M-1263	a	b	c
	65mm	62mm	260mm
	47mm	62mm	260mm
M-1264	a	b	c
	65mm	62mm	300mm
	47mm	62mm	300mm

For Aluminium, Anodized

**Finocchietto**

M-1267	a	b	c
	38mm	44mm	135mm
M-1268	a	b	c
	52mm	62mm	175mm
M-1269	a	b	c
	85mm	65mm	175mm

**Finocchietto (Modified)**

M-1270  $\frac{a \quad b \quad c \quad d}{14mm \quad 14mm \quad 120mm \quad 110mm}$

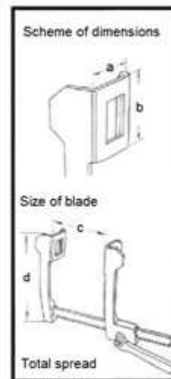
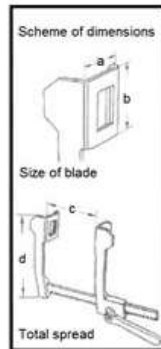

**Finocchietto - Baby**

M-1273  $\frac{a \quad b \quad c}{18mm \quad 20mm \quad 75mm}$

**Tuffier**

M-1272  $\frac{a \quad b \quad c}{50mm \quad 45mm \quad 165mm}$

**Haight**

M-1271  $\frac{a \quad b \quad c}{30mm \quad 30mm \quad 90mm}$

**Finocchietto**

M-1274	a	b	c
	40mm	40mm	165mm
M-1275	a	b	c
	45mm	65mm	200mm
M-1276	a	b	c
	70mm	65mm	250mm

**ABDOMINAL RETRACTORS**

**RIB SPREADERS**

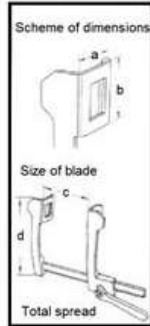

**Quervain**  
M-1277    a 35mm    b 50mm    c 180mm



**Centre Blade**  
M-1279  
55 X 70mm  
80 X 90mm

**Lateral Blades**  
M-1280  
50 X 58mm  
60 X 80mm  
72 X 85mm

**Richard**  
M-1278  
(28 cm)



**Collin - Loktite**  
M-1281  
(26 cm)

**RIB SPREADERS WITH INTERCHANGEABLE BLADES**

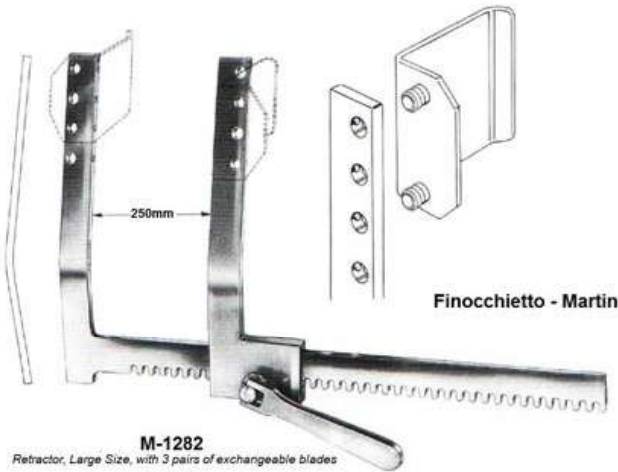

**Finocchietto - Martin**

**M-1282**  
Retractor, Large Size, with 3 pairs of exchangeable blades

**M-1283**  
Retractor, Large Size Only



*Complementary Exchangeable Blades*

**RIB SPREADERS (ALUMINIUM)**

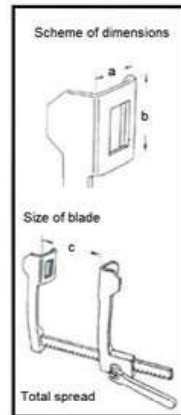

**Cooley**  
for newborns  
M-1287

a 12mm    b 17mm    c 75mm



**Cooley**  
paediatric size

M-1288    a 16mm    b 30mm    c 105mm  
M-1289    21mm    44mm    150mm

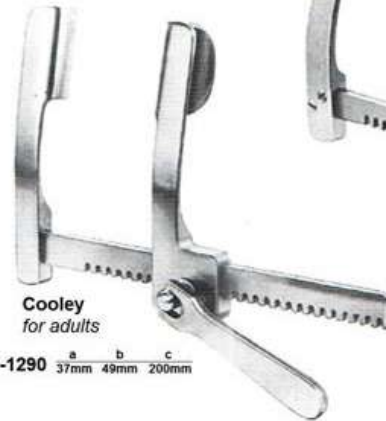

**Cooley**  
for adults

M-1290    a 37mm    b 49mm    c 200mm

# ABDOMINAL RETRACTORS

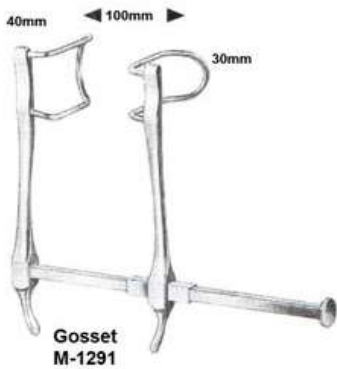

Gosset  
M-1291



Gosset  
M-1293

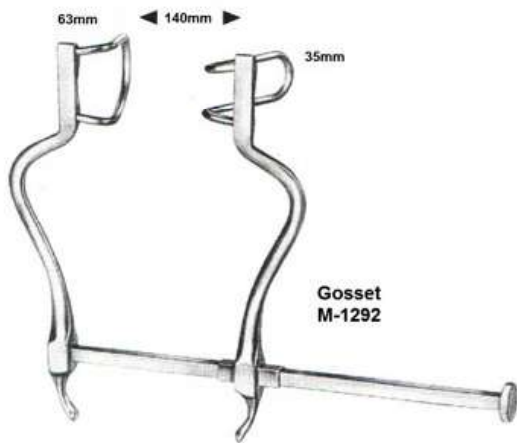

Gosset  
M-1292



Balfour - Baby  
M-1294

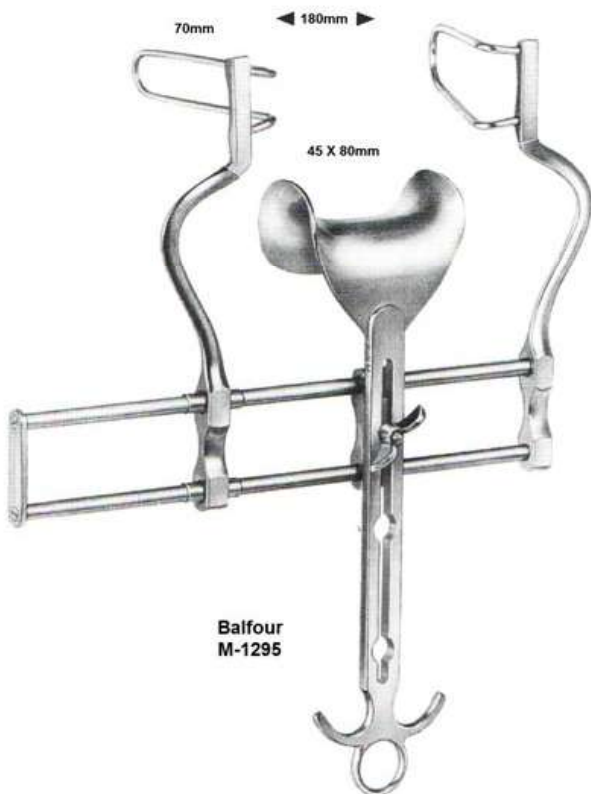

Balfour  
M-1295

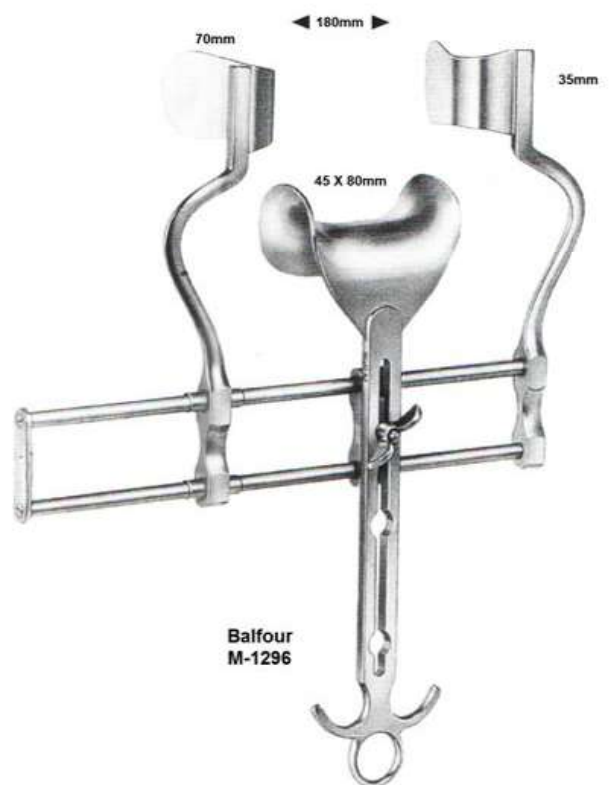

Balfour  
M-1296



**RETRACTORS**



M-1297  
45 X 45mm



M-1298  
45 X 50mm



M-1299  
55 X 70mm



Middelorpff  
(25.5 cm)

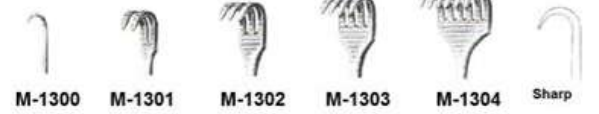

M-1300 M-1301 M-1302 M-1303 M-1304 Sharp



M-1305 M-1306 M-1307 M-1308 M-1309 Blunt



M-1310 M-1311 M-1312 M-1313 M-1314 Semi-Sharp



Volkmann  
M-1300 to M-1318  
(21.5 cm)



Volkmann  
M-1315  
(21.5 cm)



Volkmann  
M-1316  
(21.5 cm)



Volkmann  
M-1317 (20 cm) Sharp  
M-1318 (20 cm) Blunt

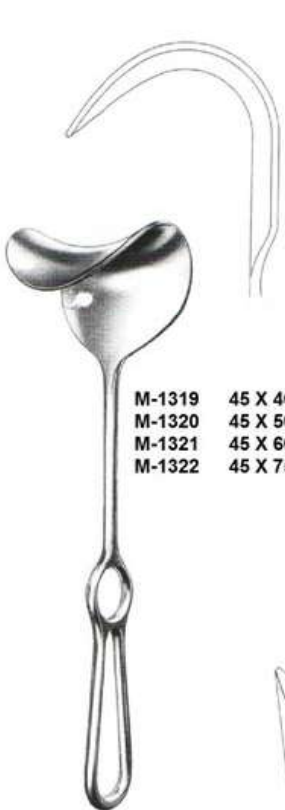

Fritsch  
(24 cm)

M-1319 45 X 40mm  
M-1320 45 X 50mm  
M-1321 45 X 60mm  
M-1322 45 X 75mm

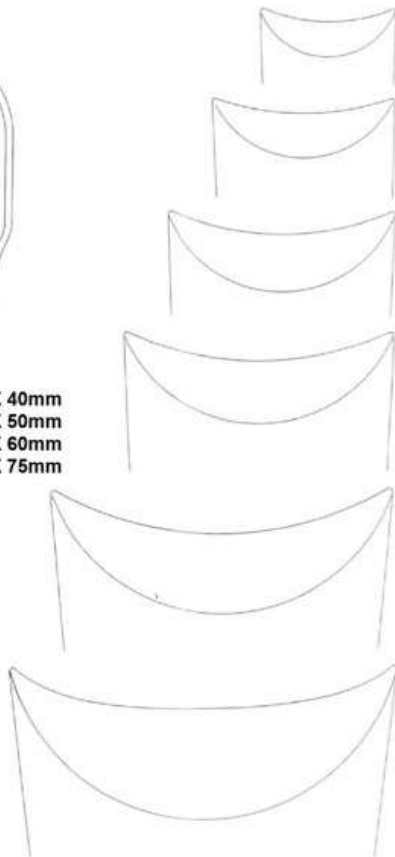

M-1323  
36 X 30mm

M-1324  
36 X 60mm

Ollier  
(22.5 cm)



33 X 20mm

Wassmund  
M-1325  
(20 cm)



M-1326  
40 X 30mm  
Sharp

M-1327  
40 X 30mm  
Blunt

Wassmund  
(23.5 cm)

**RETRACTORS**



**Gelpi - Loktite  
M-1328 (13 cm)**



**Gelpi - Siefert  
M-1329 (15 cm)**

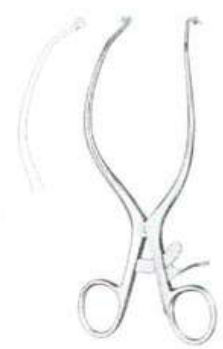

**Gelpi - Loktite  
M-1330 (18 cm)**



**Gelpi - Loktite  
M-1331 (18 cm)**



**Israel  
M-1332 to M-1335  
(25 cm)**



**M-1332  
40 X 40mm**



**M-1333  
40 X 50mm**



**M-1334  
50 X 60mm**



**M-1335  
70 X 70mm**



**Langenbeck  
M-1336  
to  
M-1340  
(21 cm)**



**M-1336  
30 X 11mm**



**M-1337  
30 X 14mm**



**M-1338  
30 X 16mm**



**M-1339  
40 X 11mm**



**M-1340  
50 X 11mm**

**Weitlaner - Wullstein  
M-1341 (Sharp)  
M-1342 (Blunt)  
(13 cm)**

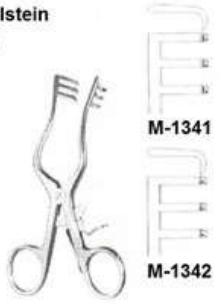

**M-1341**

**M-1342**

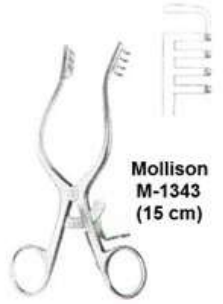

**Mollison  
M-1343  
(15 cm)**



**Adson  
M-1344 to M-1347  
(26.5 cm)**

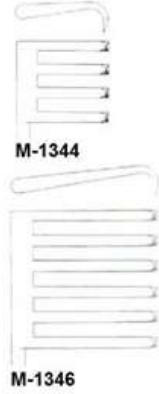

**M-1344**

**M-1346**

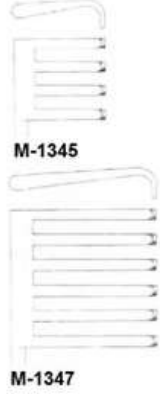

**M-1345**

**M-1347**



**Mini - Langenbeck  
M-1348 to M-1351  
(16 cm)**



**M-1348**



**M-1349**



**M-1350**



**M-1351**



**Desmarres  
M-1352 to M-1357  
(16 cm)**



**M-1352**



**M-1353**



**M-1354**



**M-1355**



**M-1356**



**M-1357**

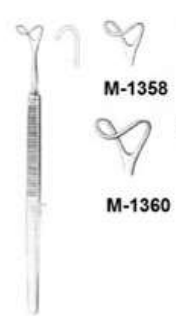

**M-1358 to M-1361  
(16 cm)**



**M-1358**



**M-1359**



**M-1360**



**M-1361**



**M-1362 to M-1367  
(16 cm)**



**M-1362**



**M-1363**



**M-1364**



**M-1365**



**M-1366**



**M-1367**



**M-1368**

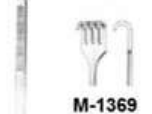

**M-1369**

**M-1368 to M-1369  
(16 cm)**

**ABDOMINAL RETRACTORS**

**RETRACTORS**

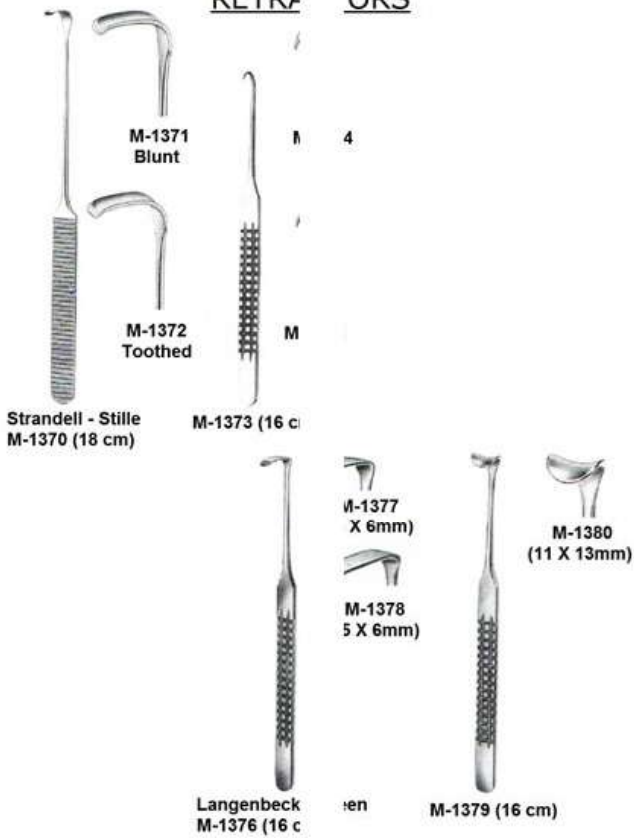

**NERVE ROOT RETRACTORS**

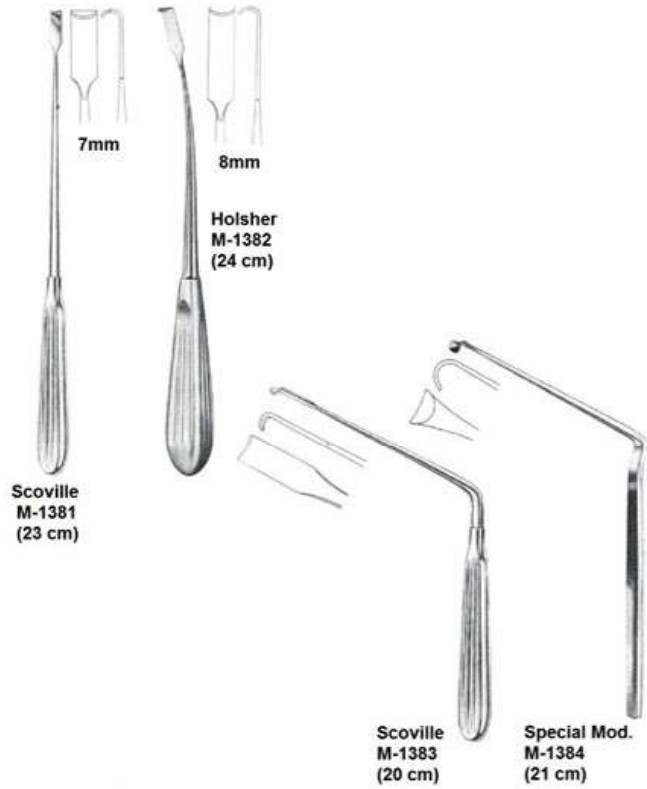

**RETRACTORS**

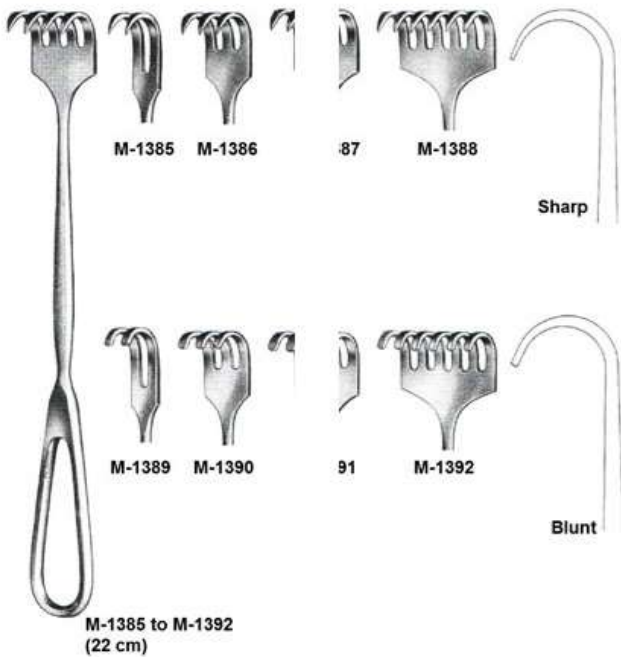

**RETRACTORS**

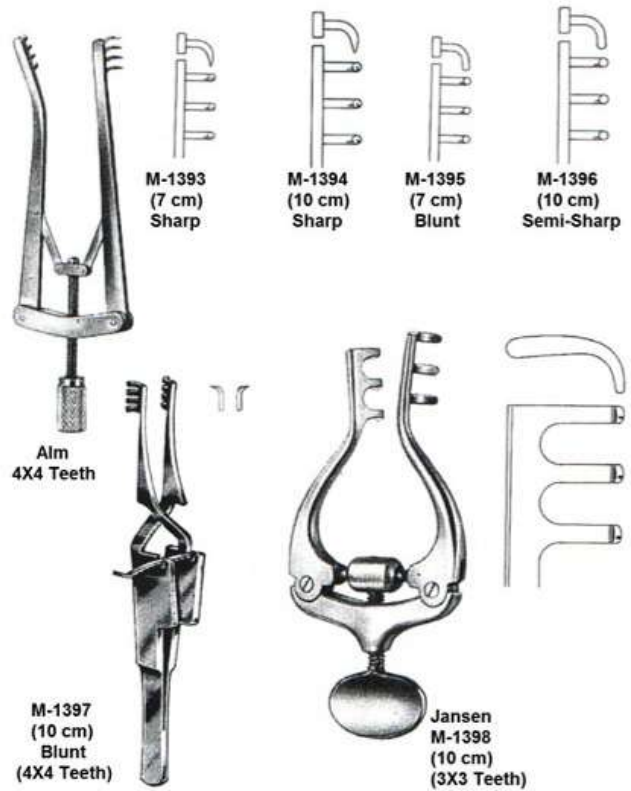

## RETRACTORS

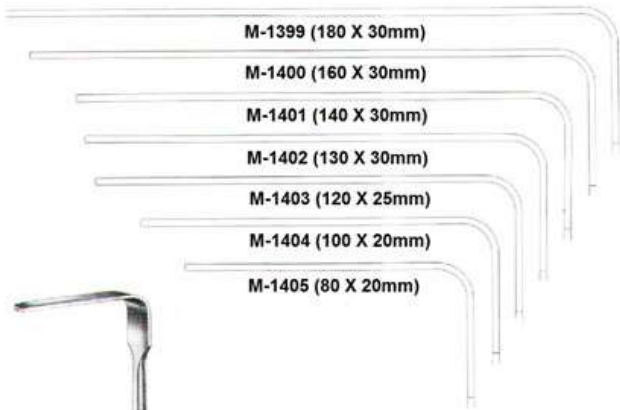

- M-1399 (180 X 30mm)
- M-1400 (160 X 30mm)
- M-1401 (140 X 30mm)
- M-1402 (130 X 30mm)
- M-1403 (120 X 25mm)
- M-1404 (100 X 20mm)
- M-1405 (80 X 20mm)



Brunner  
(25 cm)

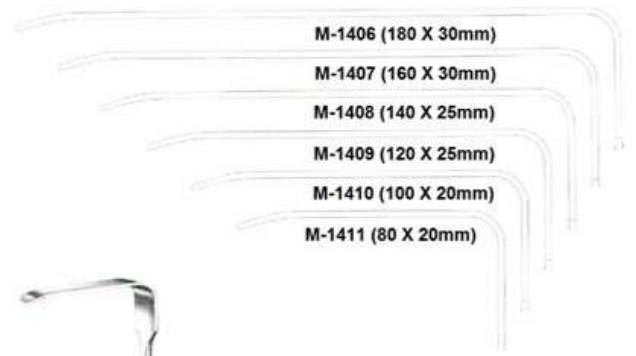

- M-1406 (180 X 30mm)
- M-1407 (160 X 30mm)
- M-1408 (140 X 25mm)
- M-1409 (120 X 25mm)
- M-1410 (100 X 20mm)
- M-1411 (80 X 20mm)



Brunner  
(25 cm)



M-1412  
25mm

M-1413  
38mm

M-1415  
50mm

M-1416  
100mm

Deaver  
(31 cm)



M-1417  
(127 X 40mm)

M-1418  
(127 X 62mm)

Harrington  
(32 cm)

# RETRACTORS



**OBSTETRICAL (MID-WIFERY) FORCEPS**



**Dee Lee**  
M-1433  
(30 cm)



**De Lee**  
M-1434 (36 cm)  
M-1435 (39 cm)



**Elliot**  
M-1436 (32 cm)  
M-1437 (38 cm)



**Mc Lean**  
M-1438 (36 cm)



**Simpson - Luikart**  
M-1439 (36 cm)

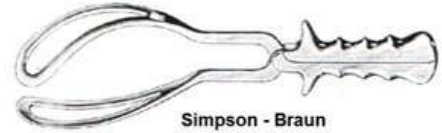

**Simpson - Braun**  
M-1440 (36 cm)



**Simpson**  
M-1441 (30 cm)



**Naegele**  
M-1442 (36 cm)  
M-1443 (40 cm)

*specialty for obstetrics in breech presentation*



**Kielland**  
M-1444 (41 cm)



**Kielland - Luikart**  
M-1445 (40 cm)



**Piper**  
M-1446 (44 cm)

**RETRACTORS**

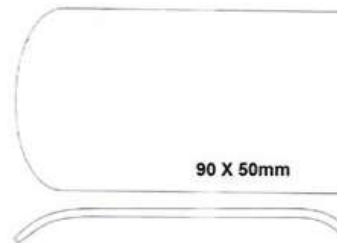

90 X 50mm

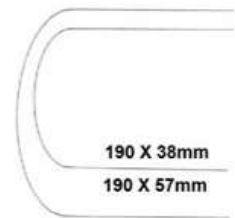

190 X 38mm  
190 X 57mm



**Mikulicz**  
M-1447 (26 cm)



**Kelly**  
M-1448  
(27 cm)

TENACULUM FORCEPS

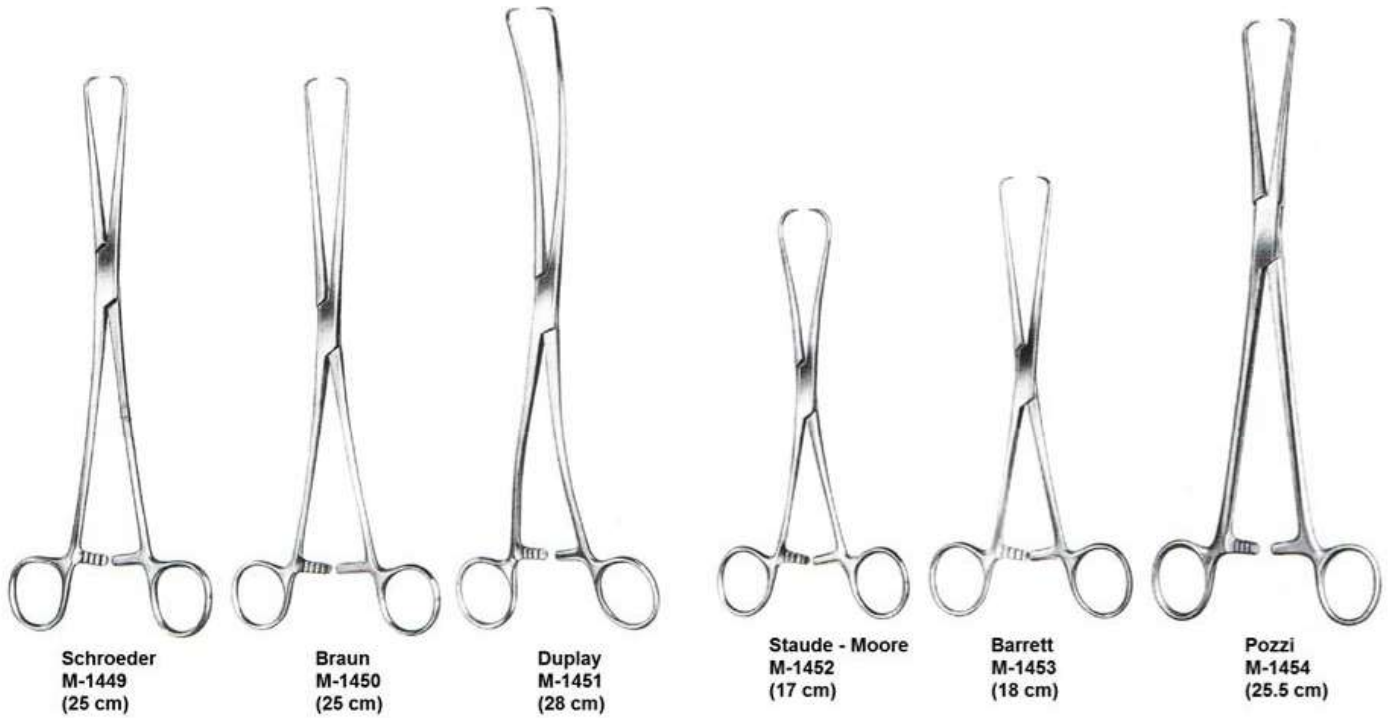

RETRACTORS, ENDOSPECULA

TENACULUM FORCEPS

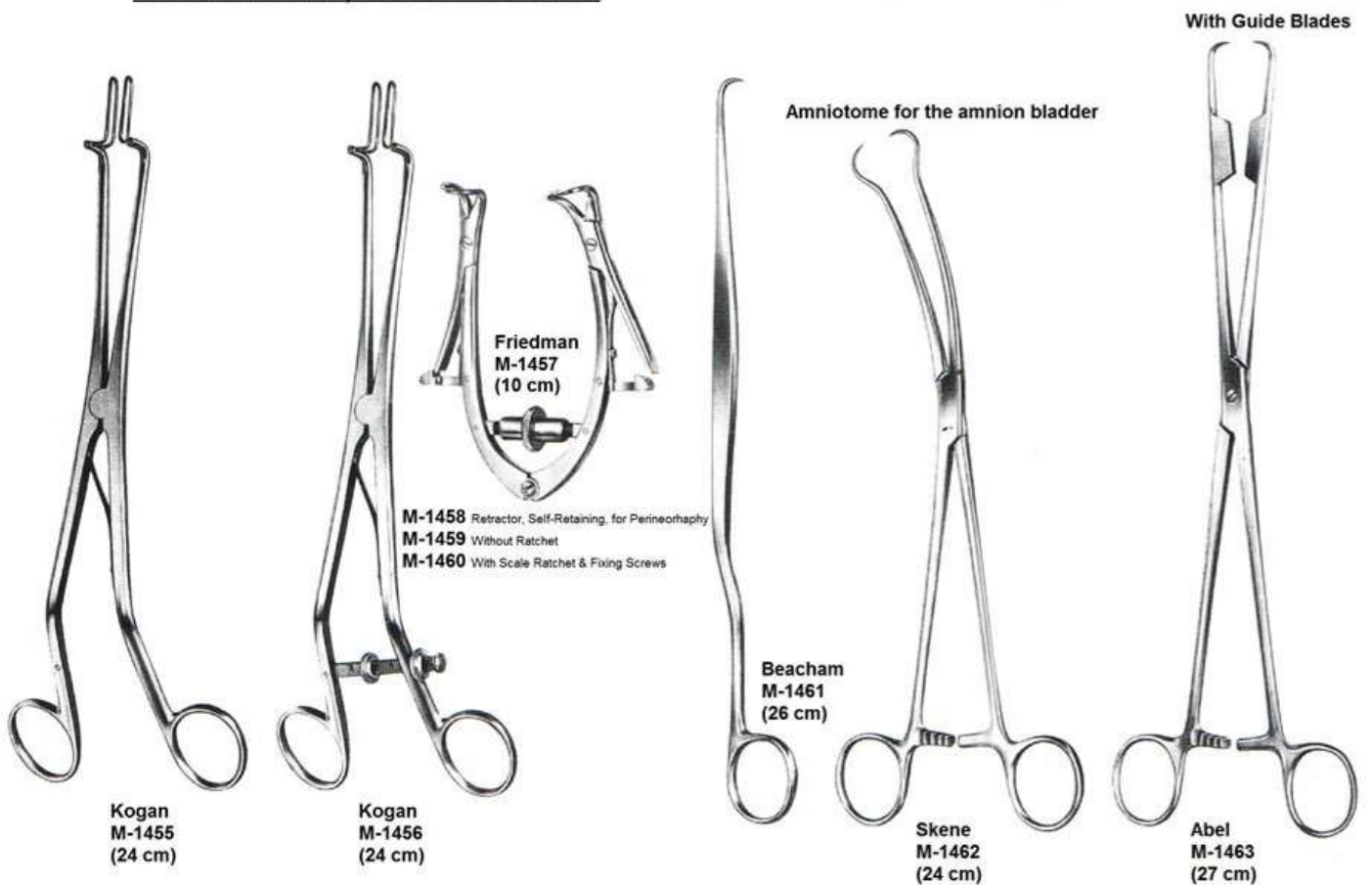

**DILATING BOUGIES, METAL CATHETERS**

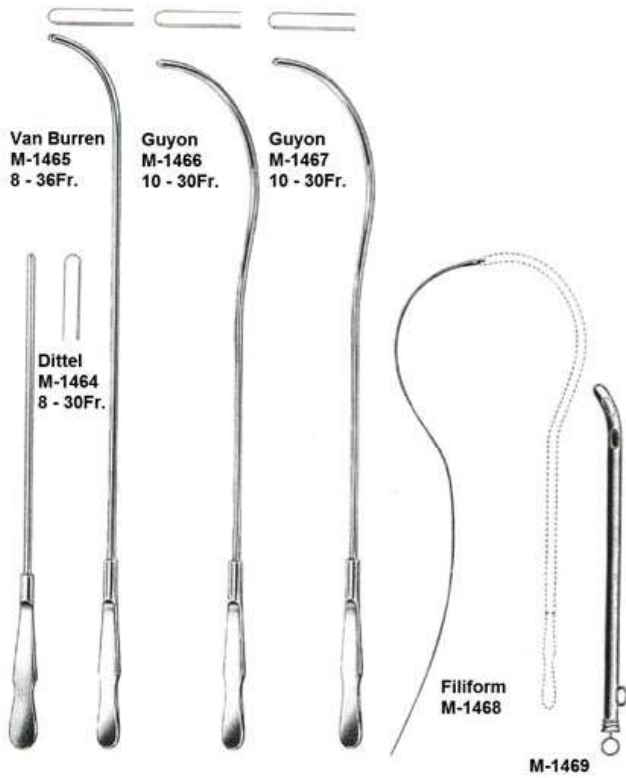

**CATHETER INTRODUCING INSTRUMENTS**



**MEATOTOME, SECRETION SCOOPS, PENIS SEIZING FORCEPS**

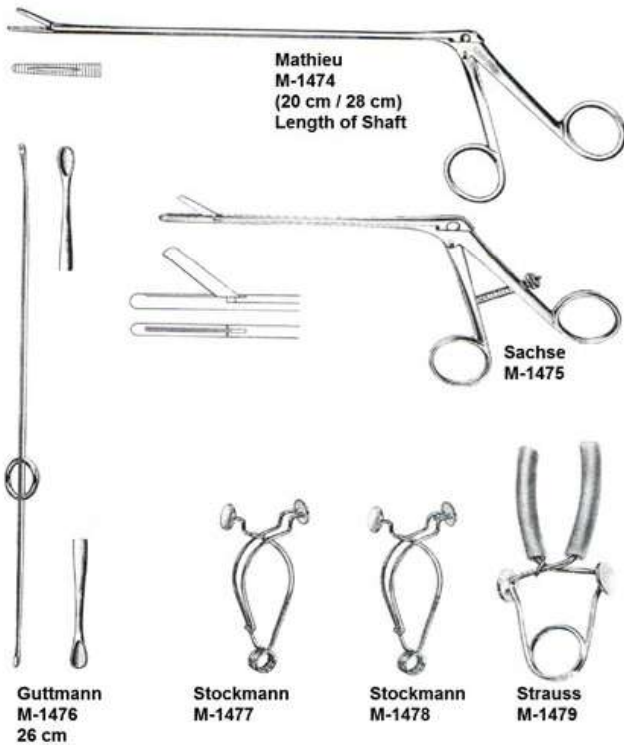

**LAMINECTOMY RONGEURS**

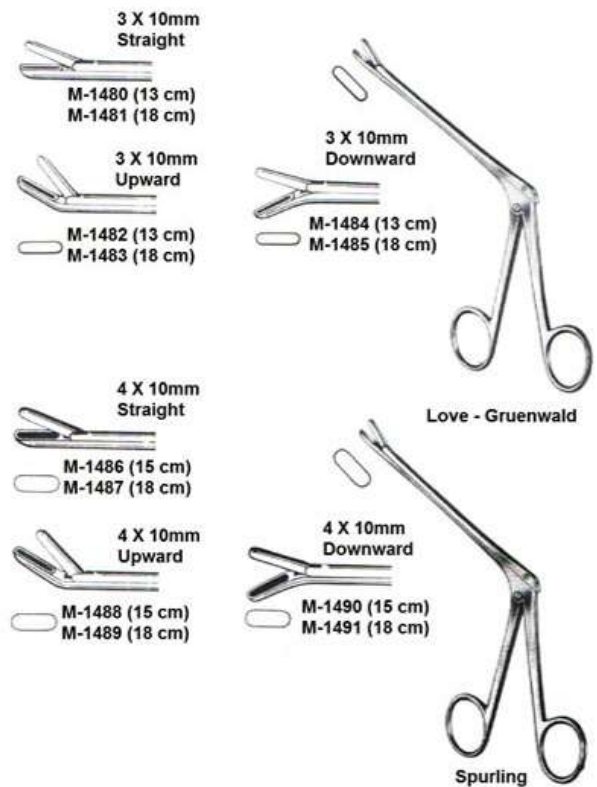



UTERINE POLYPUS FORCEPS  
&  
TENACULUM FORCEPS



Museux  
M-1492  
(24 cm)

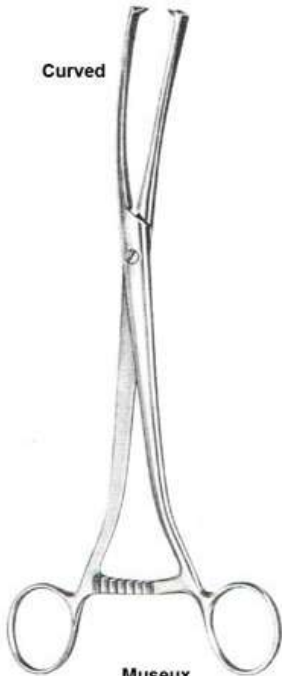

Curved

Museux  
M-1493  
(24 cm)

UTERINE ELEVATING FORCEPS  
&  
TENACULUM FORCEPS

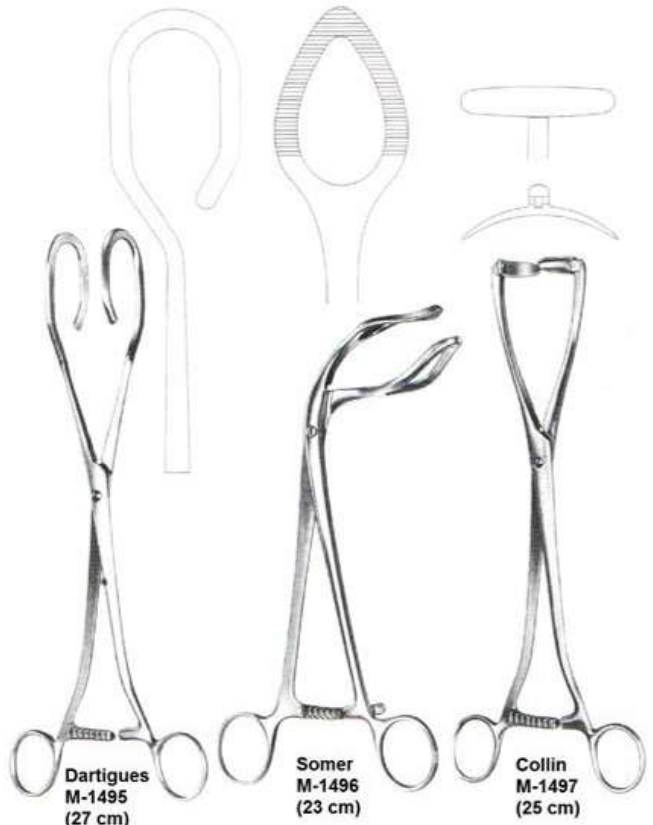

Dartigues  
M-1495  
(27 cm)

Somer  
M-1496  
(23 cm)

Collin  
M-1497  
(25 cm)

UTERINE POLYPUS FORCEPS  
&  
TENACULUM FORCEPS

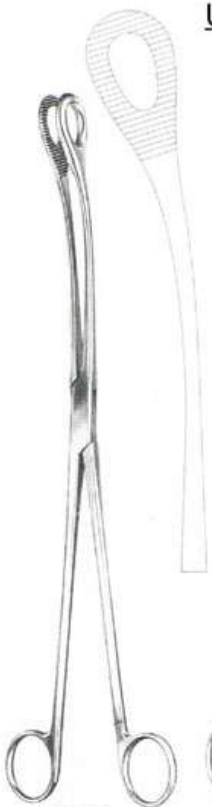

Doyen  
M-1498  
(20 cm)

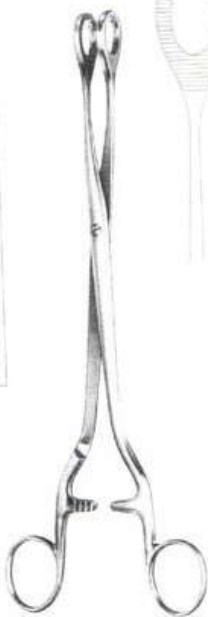

Noto  
M-1499  
(27 cm)

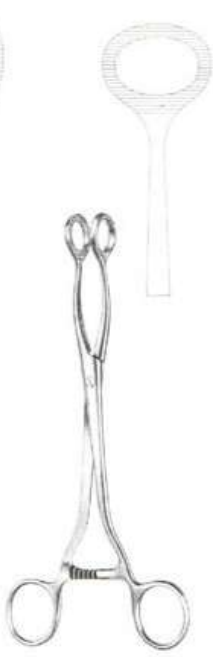

Kelly  
M-1500  
(32 cm)

UTERINE ELEVATING FORCEPS  
&  
TENACULUM FORCEPS



Czerny  
M-1501  
(20.5 cm)

Braun  
M-1502  
(15.5 cm)

Braun  
M-1503  
(26 cm)

FISTULA HOOKS, CONE KNIVES

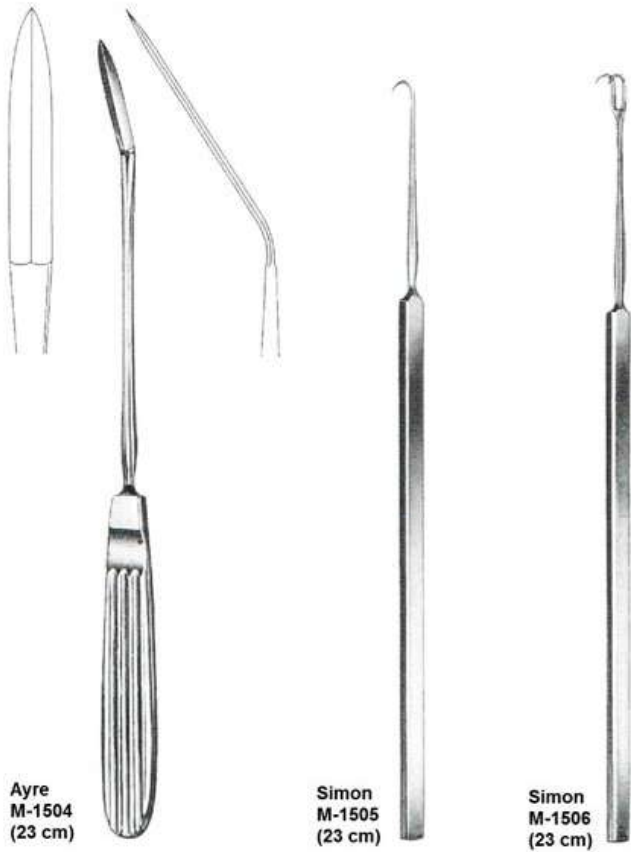

TENACULUM FORCEPS & MYOMA INSTRUMENTS

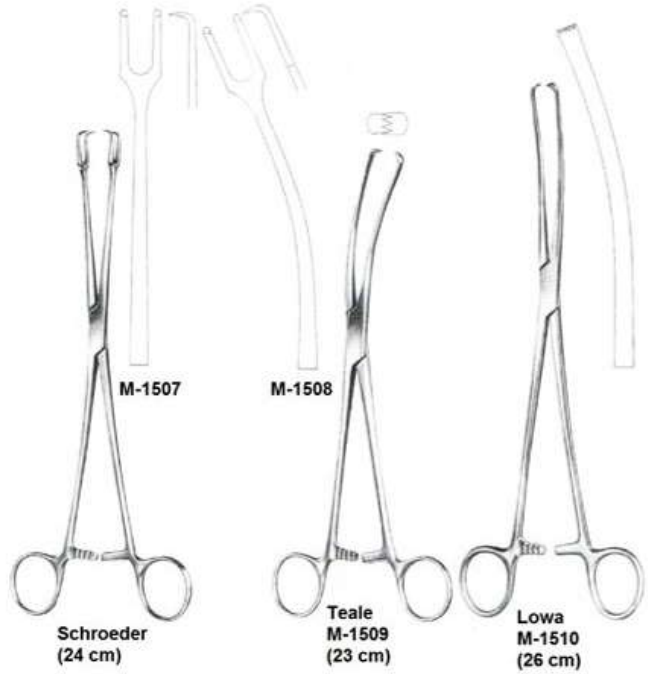

TENACULUM FORCEPS

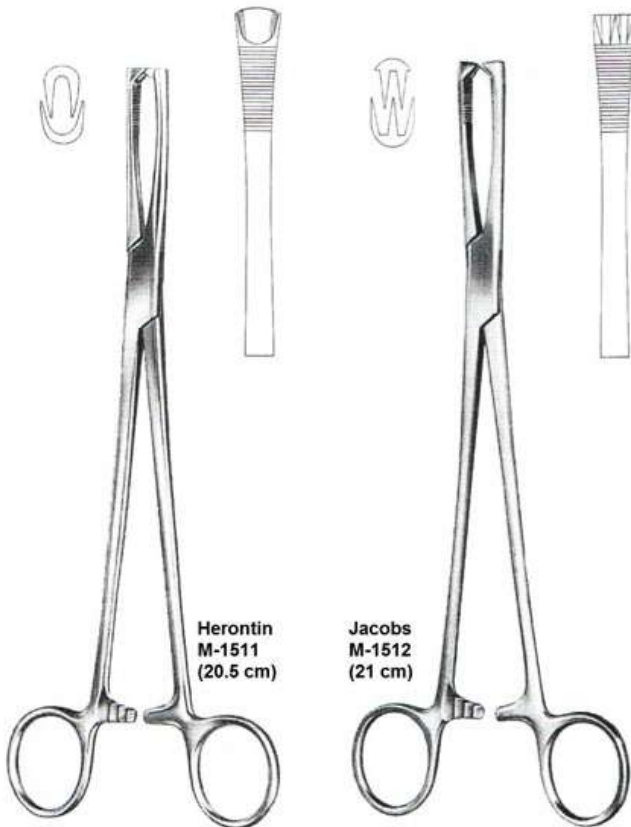

TENACULUM FORCEPS & MYOMA INSTRUMENTS

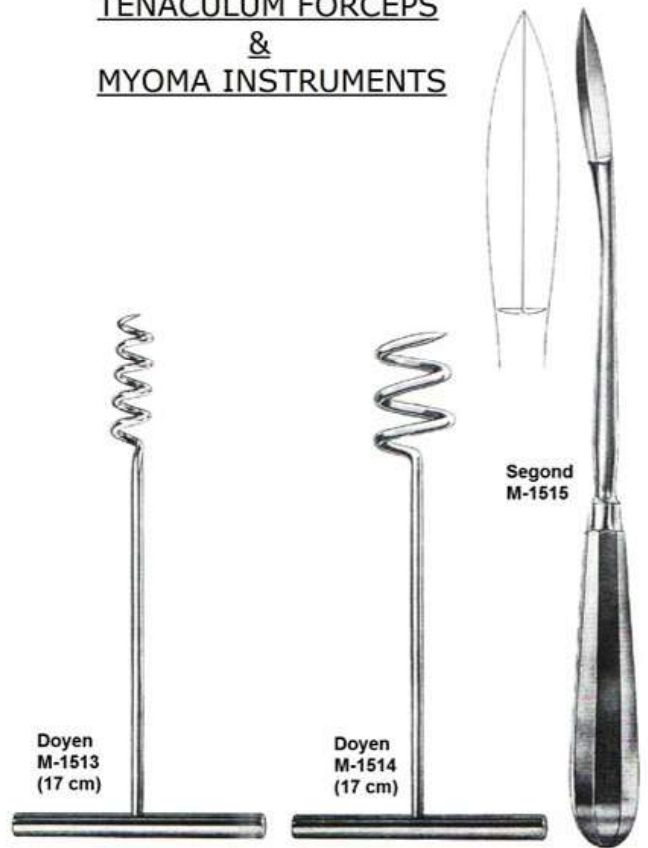

UTERINE SOUNDS & DEPRESSORS



**Sims M-1516 (32 cm)**  
**Martin M-1517 (32 cm)**  
**Collin M-1518 (28 cm)**  
**Valleix M-1519 (25 cm)**  
**Braun M-1520 (28 cm)**

SUCTION BIOPSY CURETTES

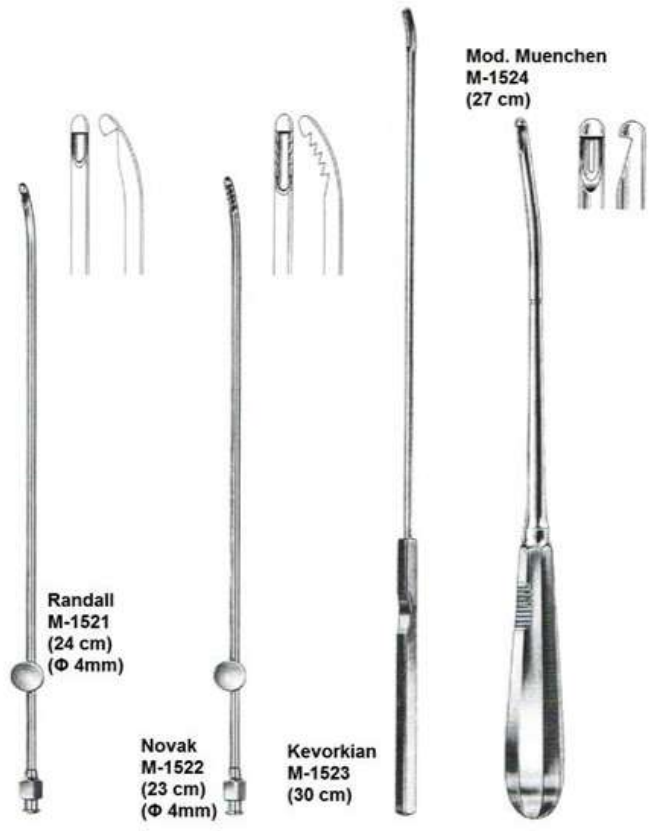

**Randall M-1521 (24 cm) (Φ 4mm)**  
**Novak M-1522 (23 cm) (Φ 4mm)**  
**Kevorkian M-1523 (30 cm)**  
**Mod. Muenchen M-1524 (27 cm)**

TRANSCERVICAL ASPIRATION INSTRUMENT

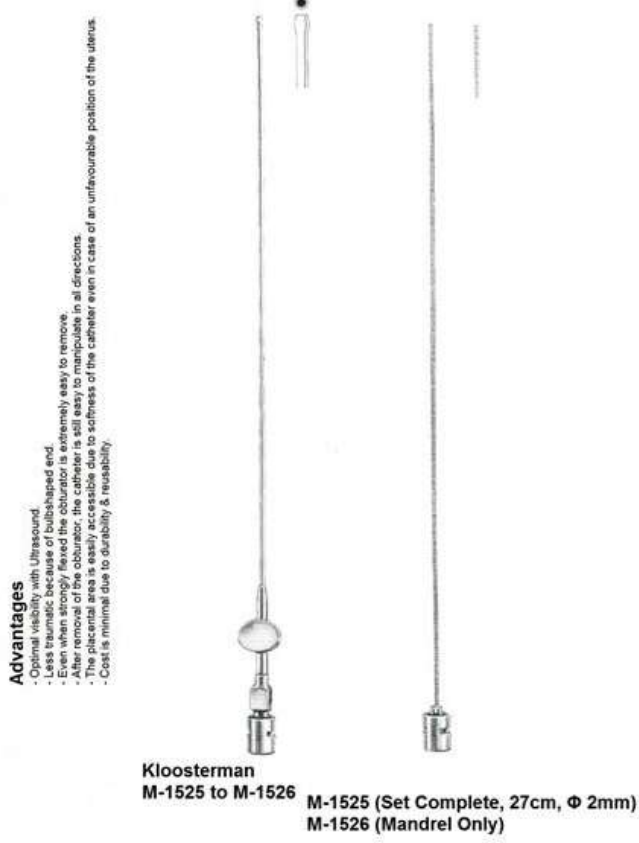

**Advantages**

- Optimal visibility with Ultrasound
- Less traumatic because of bulb-shaped end
- Even when strongly flexed the obturator is extremely easy to remove.
- After removal of the obturator, the catheter is still easy to manipulate in all directions.
- The placental area is easily accessible due to softness of the catheter even in case of an unfavourable position of the uterus.
- Cost is minimal due to durability & reusability.

**Kloosterman M-1525 to M-1526**  
**M-1525 (Set Complete, 27cm, Φ 2mm)**  
**M-1526 (Mandrel Only)**

OVUM CURETTES, ABORTION SCOOPS, UMBILICAL CLAMPS

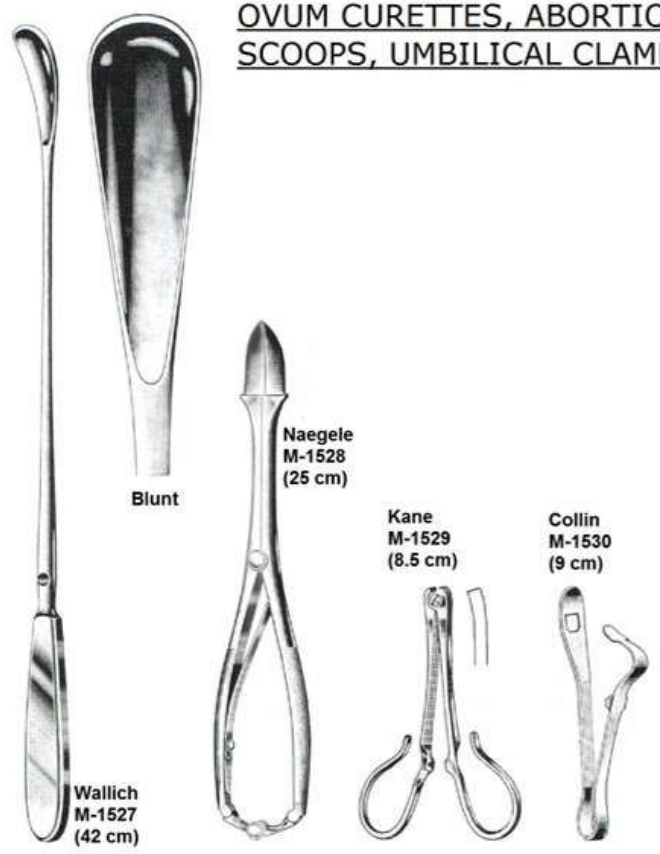

**Wallich M-1527 (42 cm)**  
**Naegele M-1528 (25 cm)**  
**Kane M-1529 (8.5 cm)**  
**Collin M-1530 (9 cm)**

PELVIMETERS



**Martin**  
M-1531  
(34 cm)  
cm/inch scale



**Collin**  
M-1532  
(35 cm)  
cm scale



**Breisky**  
M-1533  
(33 cm)  
cm/inch scale

OVUM CURETTES, ABORTION SCOOPS



Toothed Back

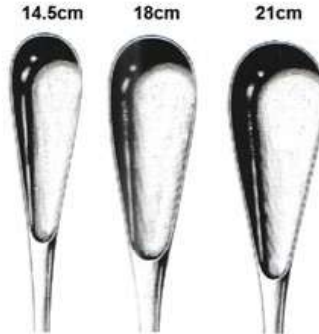

M-1534 M-1535 M-1536  
Blunt



Cuzzi  
(30 cm)



Pestalozza  
M-1537  
(30 cm)

UTERINE SCOOPS

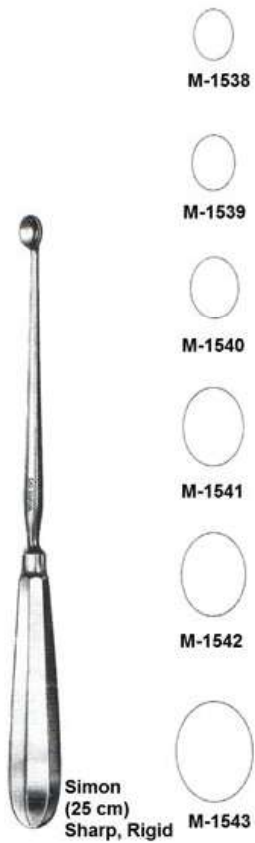

**Simon**  
(25 cm)  
Sharp, Rigid



**Schroeder**  
(30 cm)  
Sharp, Rigid



UTERINE SCOOPS

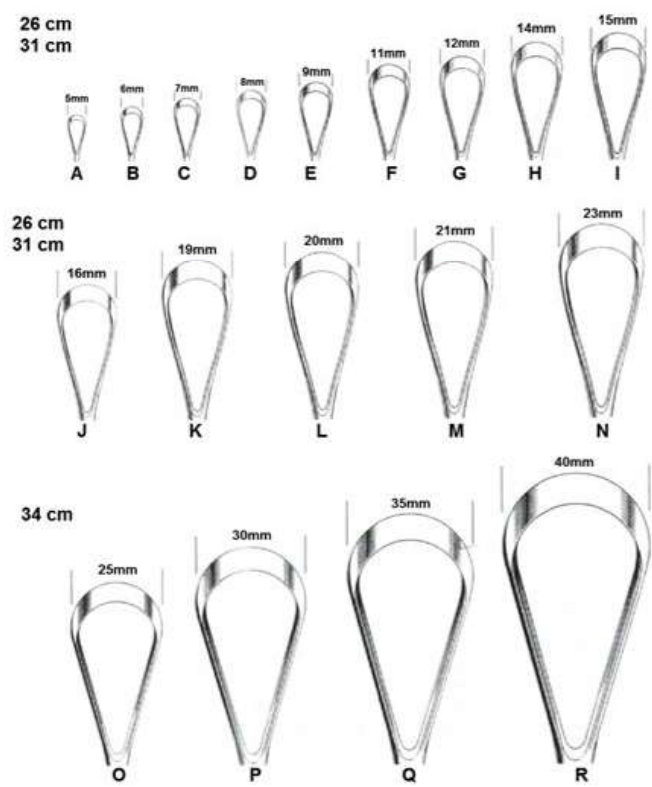

GALL STONE FORCEPS, CATCHERS & SCOOPS

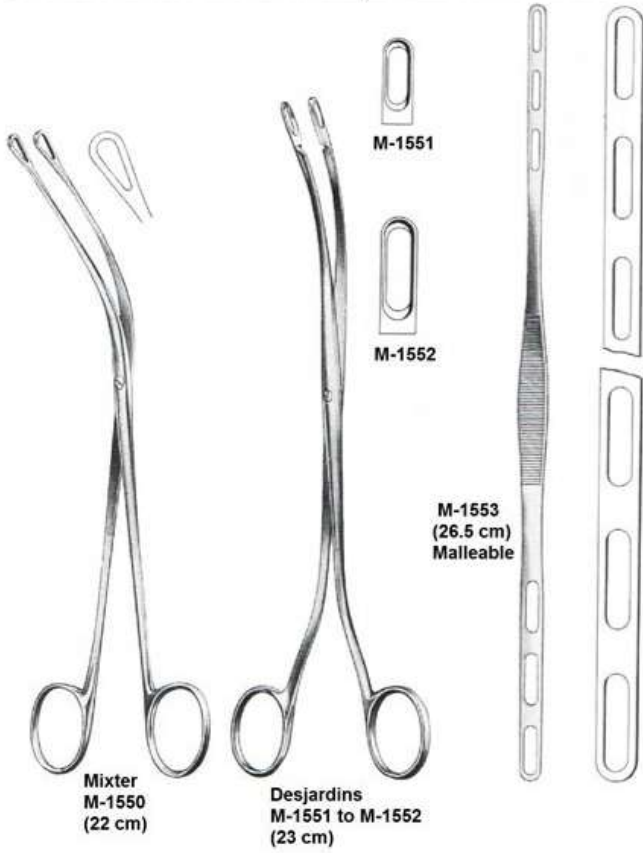

NEPHROSTOMY FORCEPS

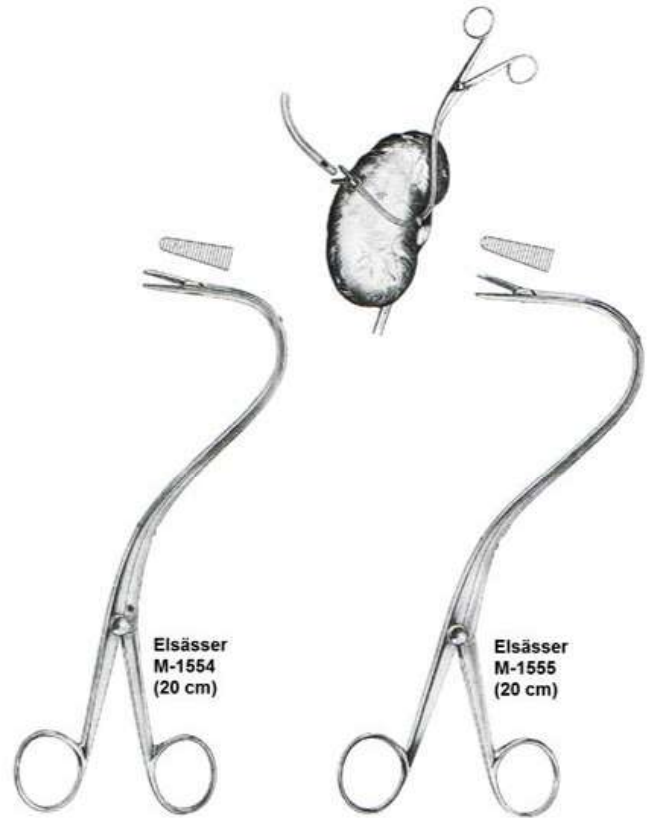

KIDNEY FORCEPS, CATHETER INTRODUCERS



GALL STONE FORCEPS

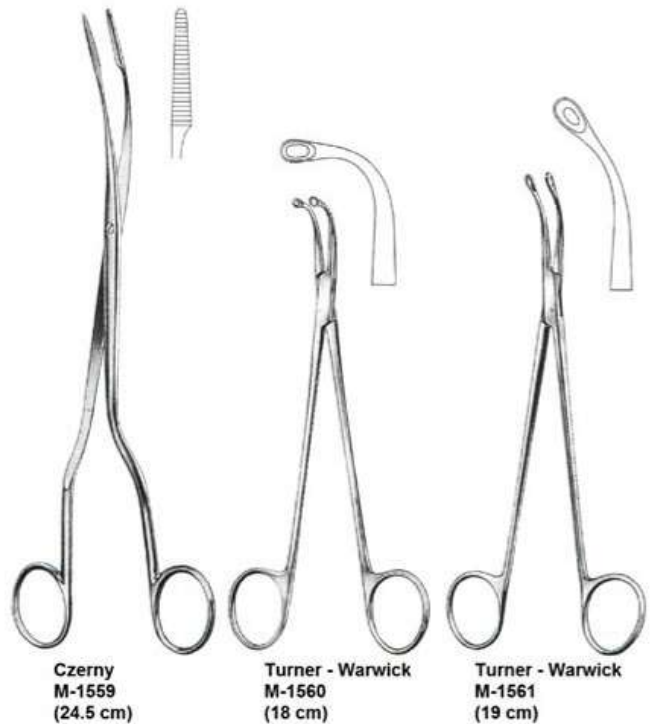

## GALL STONE SCOOPS

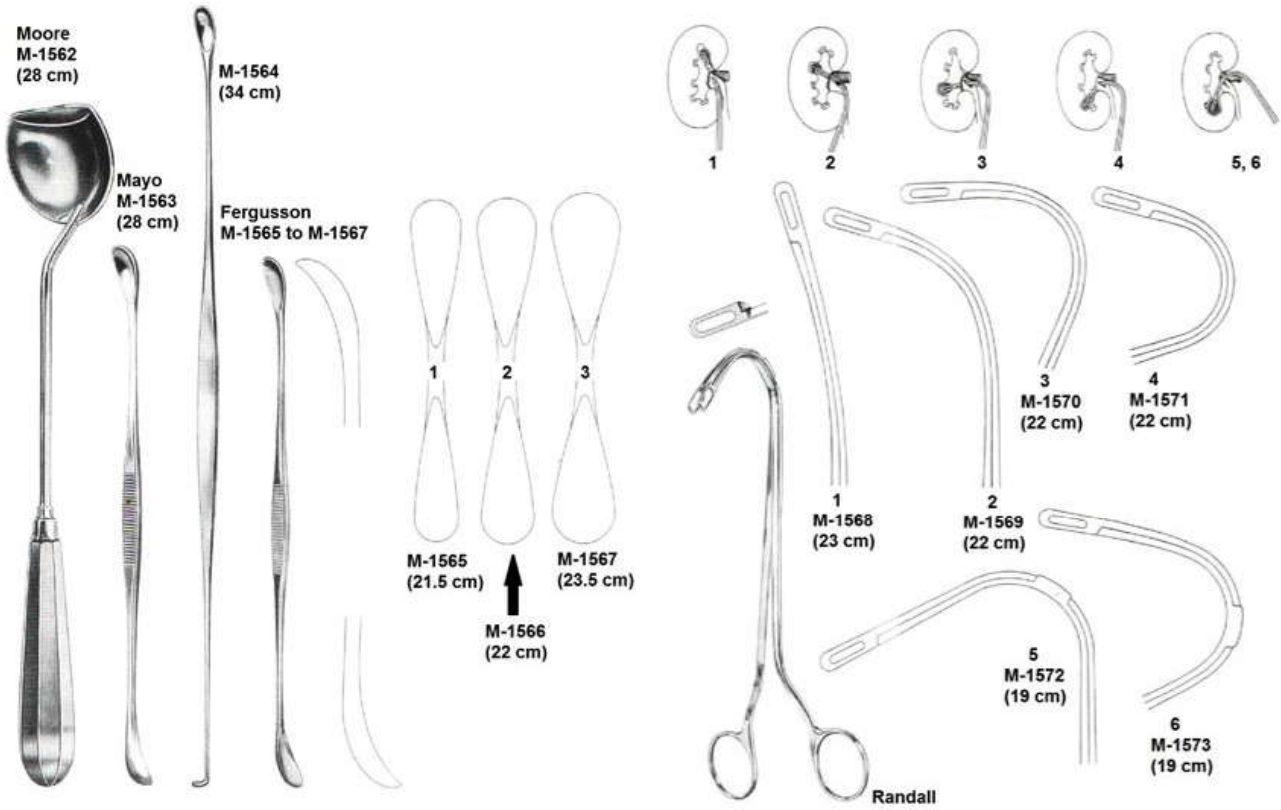

## GALL STONE SCOOPS

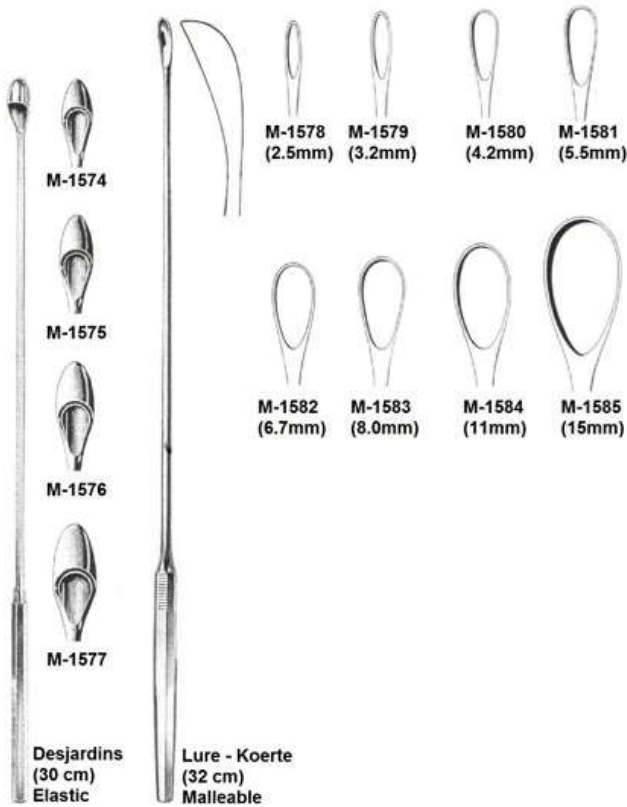

## GALL STONE PROBES, GALL DUCT DILATORS

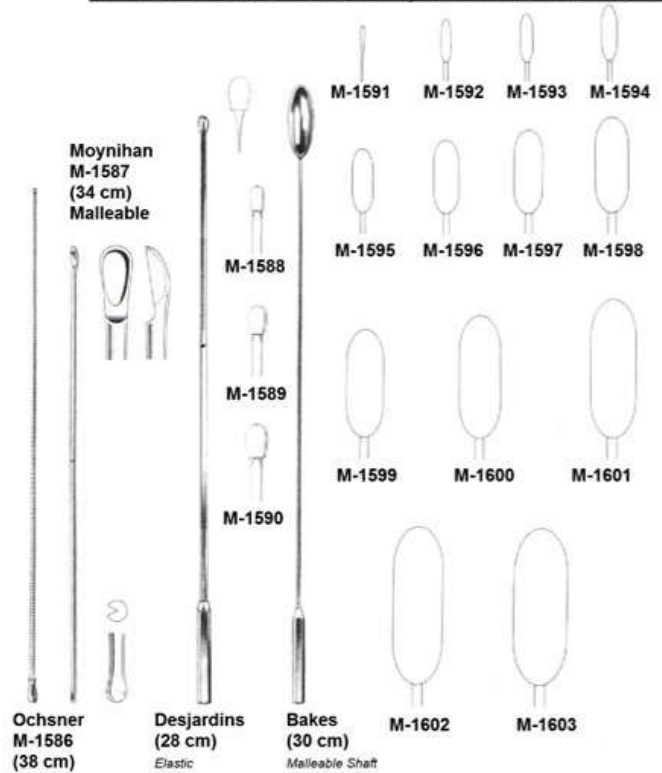

GALL STONE FORCEPS

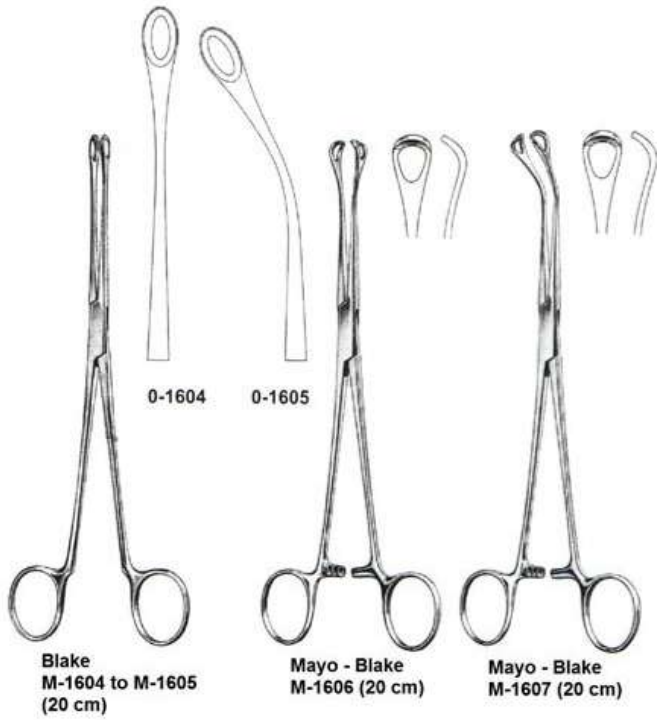

SCALP FLAP FORCEPS, ELEVATING SPOONS

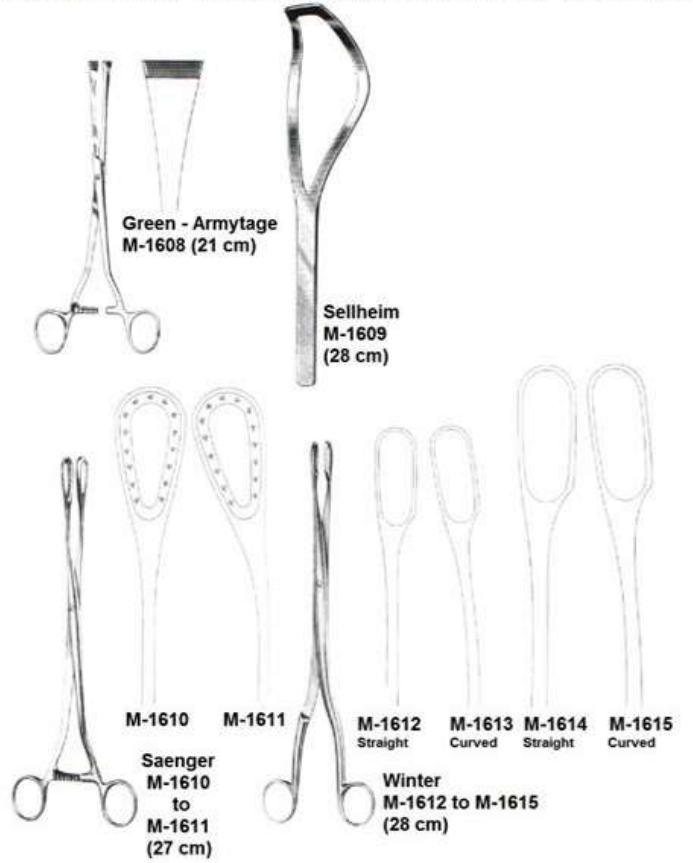

GALL STONE FORCEPS

URETER CALCULUS FORCEPS

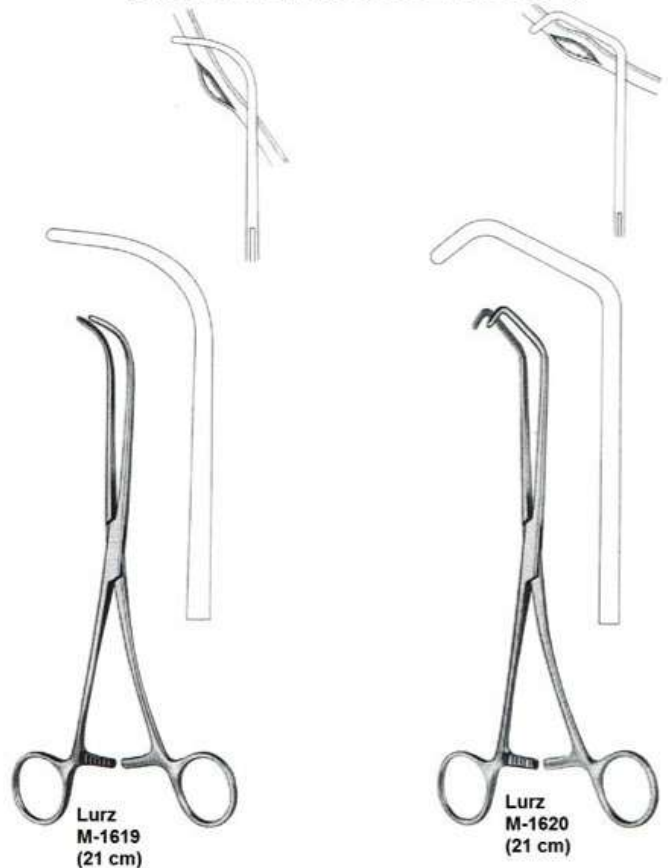
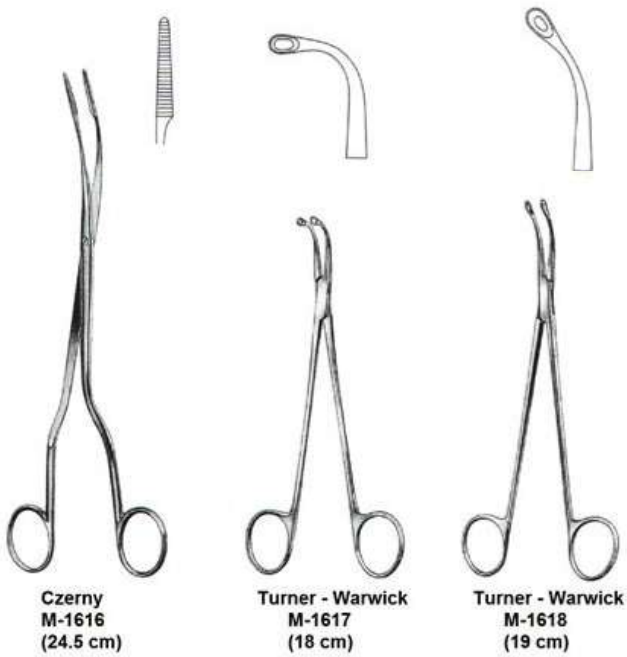

**RECTAL BIOPSY SPECIMEN FORCEPS  
HAEMORRHOIDAL (PILE) FORCEPS**

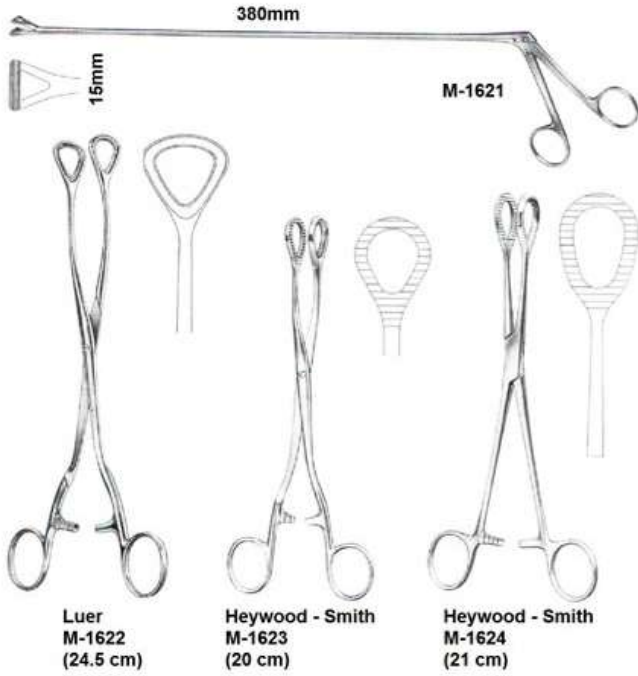

**PROSTATECTOMY INSTRUMENTS**

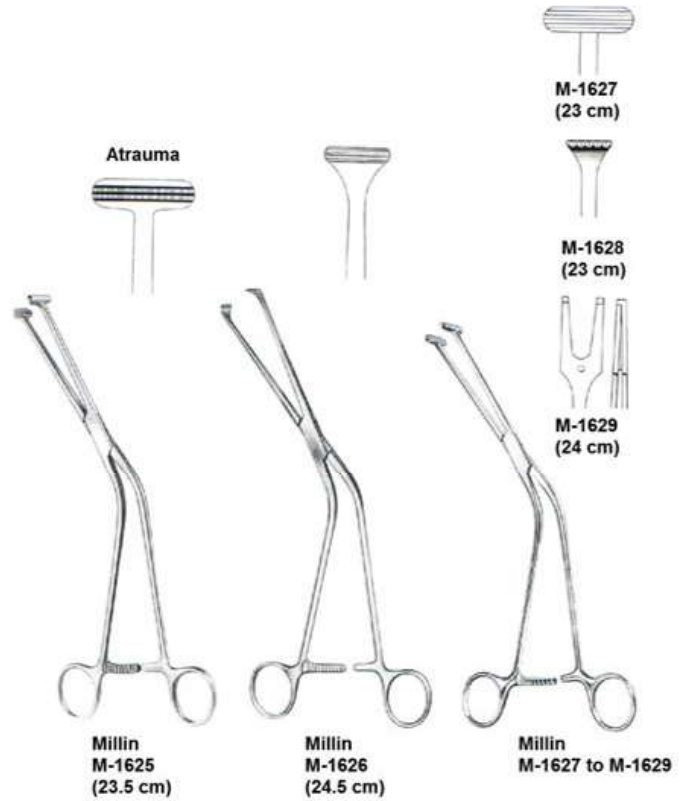

**CERVICAL BIOPSY & SPECIMEN FORCEPS**

*Its S-shaped construction allows clear view & sharply delineated excisions.*

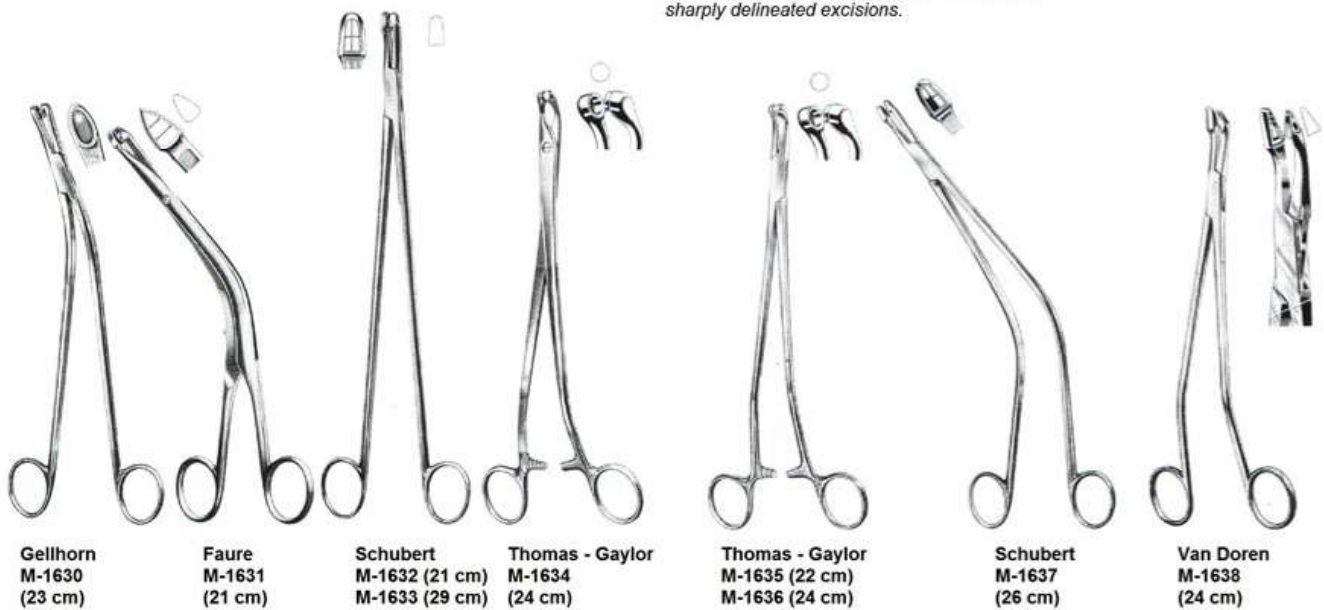



## UTERINE DILATORS

**M-1639**  
Set of 8 Dilators  
Φ3.0/4.0mm - Φ17.0/18.0mm  
in boilable canvas roll



**M-1640**  
Set of 5 Dilators



**Hank**  
**M-1643**  
Set of 6 Dilators  
(in canvas roll)



**M-1641**  
Set of 13 Dilators  
Φ1.0/2.0mm - Φ25.0/26.0mm  
(in metal case with hinged lid)



**M-1642**  
Set of 15 Dilators

American Scale

Hank  
M-1644  
to  
M-1649

Hank  
M-1644 Φ4.5-5mm  
M-1645 Φ5.5-6mm  
M-1646 Φ6.5-7mm  
M-1647 Φ7.5-8mm  
M-1648 Φ8.5-9mm  
M-1649 Φ9.5-10mm

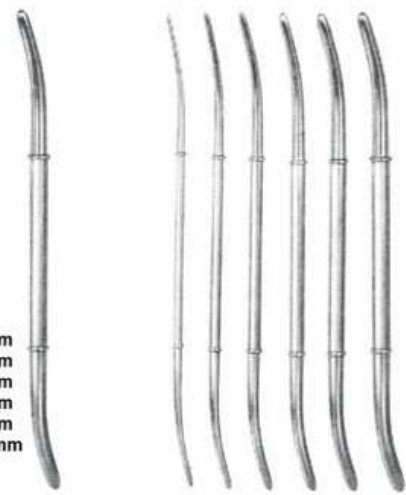

**Hank**  
**M-1650**  
Set of 6 Dilators

**M-1651 (Set of 14 Dilators)**  
(Φ4.0-17.0mm), In metal case with hinged lid

**M-1652 (Set of 26 Dilators)**  
(Φ1.0-26.0mm), In metal case with hinged lid

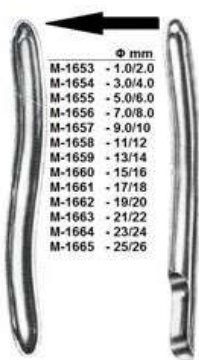

Pieces Per Set	Set
14	M-1666
26	M-1667

**M-1668**  
Set of 8 Dilators Φ3.0/4.0mm - Φ17.0/18.0mm

**M-1669**  
Set of 13 Dilators Φ1.0/2.0mm - Φ15.0/26.0mm



## UTERINE

Sharp

Blunt

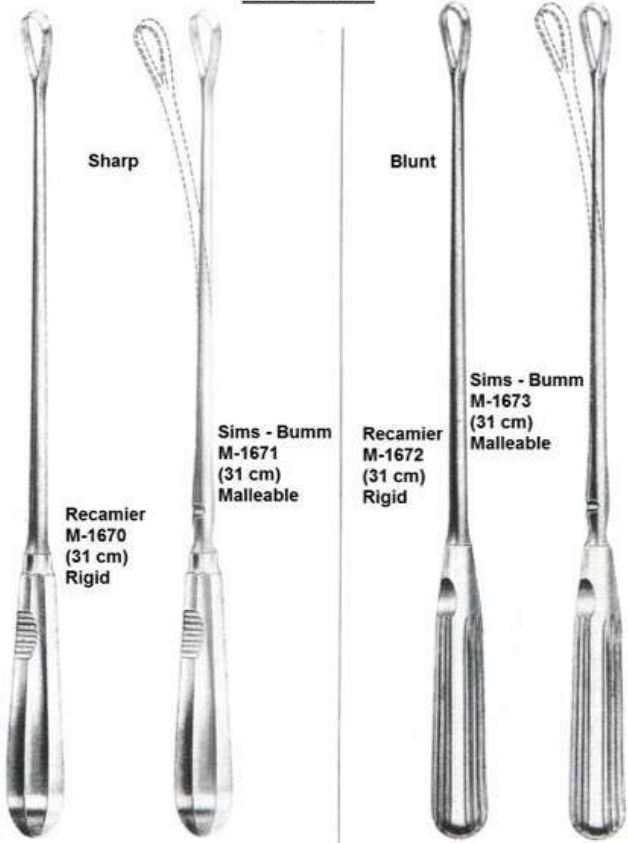

**Recamier**  
**M-1670**  
(31 cm)  
Rigid

**Sims - Bumm**  
**M-1671**  
(31 cm)  
Malleable

**Recamier**  
**M-1672**  
(31 cm)  
Rigid

**Sims - Bumm**  
**M-1673**  
(31 cm)  
Malleable

**ATRAUMA SIGMOID ANASTOMOSIS FORCEPS**

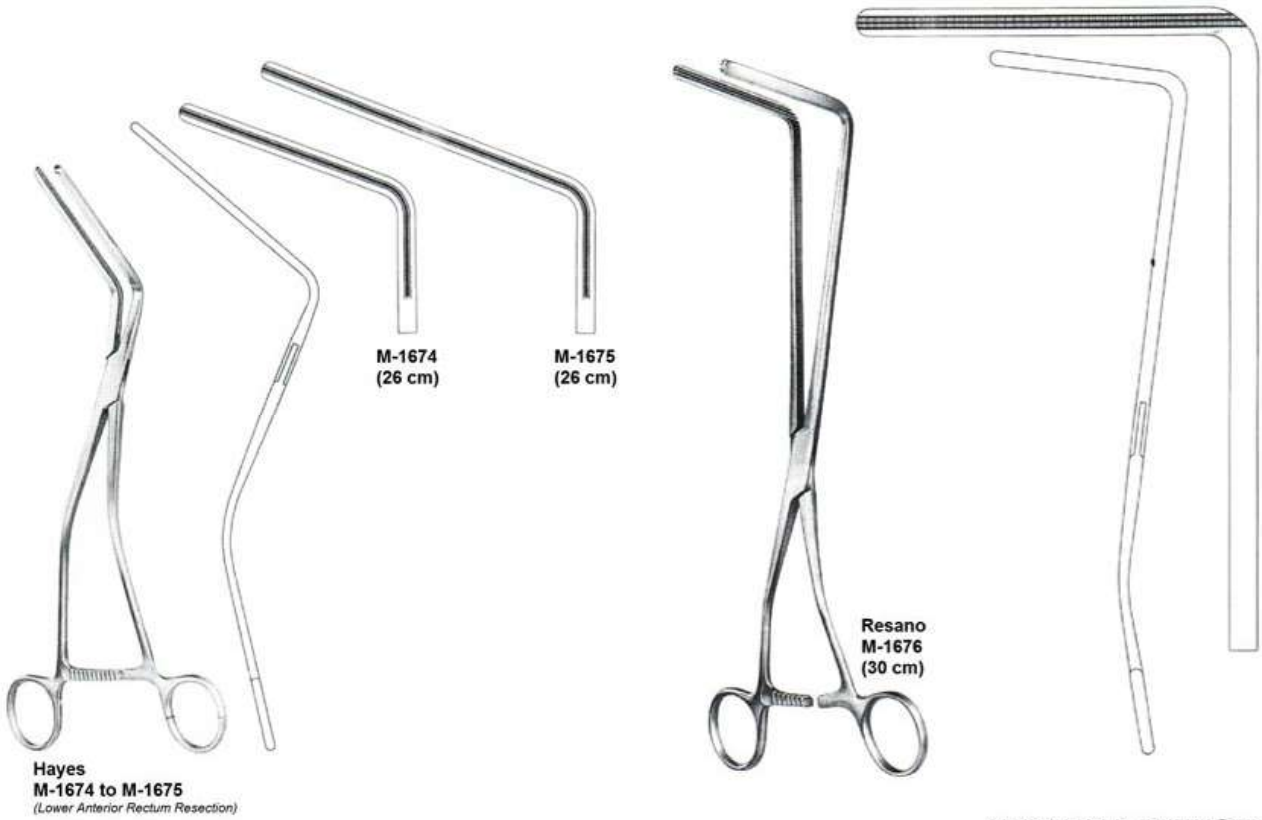

**Hayes**  
M-1674 to M-1675  
*(Lower Anterior Rectum Resection)*

**Resano**  
M-1676  
(30 cm)

**ATRAUMA INTESTINAL & STOMACH CLAMP FORCEPS**  
(WITH MARTIN SERRATIONS)



**Veidenheimer**  
M-1677 (23 cm)

**Fehland**  
M-1678  
(24 cm)

M-1679

M-1680

**Scudder - Atrauma**  
M-1679 - M-1680  
(35 cm)

M-1681  
(24 cm)

**Brunner**  
M-1681

**ATRAUMA INTESTINAL & STOMACH CLAMP FORCEPS**  
 ( WITH MARTIN SERRATIONS )



**Kocher - Atrauma**  
 M-1682 to M-1685



**M-1682**  
 (22 cm)



**M-1683**  
 (25 cm)



**M-1684**  
 (28 cm)



**Doyen - Atrauma**  
 M-1685 to M-1688



**M-1685**  
 (16 cm)



**M-1686**  
 (18 cm)



**M-1687**  
 (21 cm)



**M-1688**  
 (23 cm)



**Doyen - Atrauma**  
 M-1689 to M-1692



**M-1689**  
 (16 cm)



**M-1690**  
 (18 cm)



**M-1691**  
 (21 cm)



**M-1692**  
 (23 cm)



**Kocher - Atrauma**  
 M-1693 to M-1695



**M-1693**  
 (22 cm)



**M-1694**  
 (25 cm)



**M-1695**  
 (28 cm)

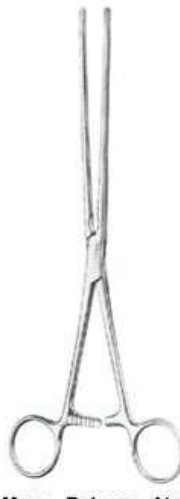

**Mayo - Robson - Atrauma**  
 M-1696 (25 cm)



**Mayo - Robson - Atrauma**  
 M-1697 (25 cm)



ASPIRATING CURETTES



SEPTUM COMPRESSION FORCEPS

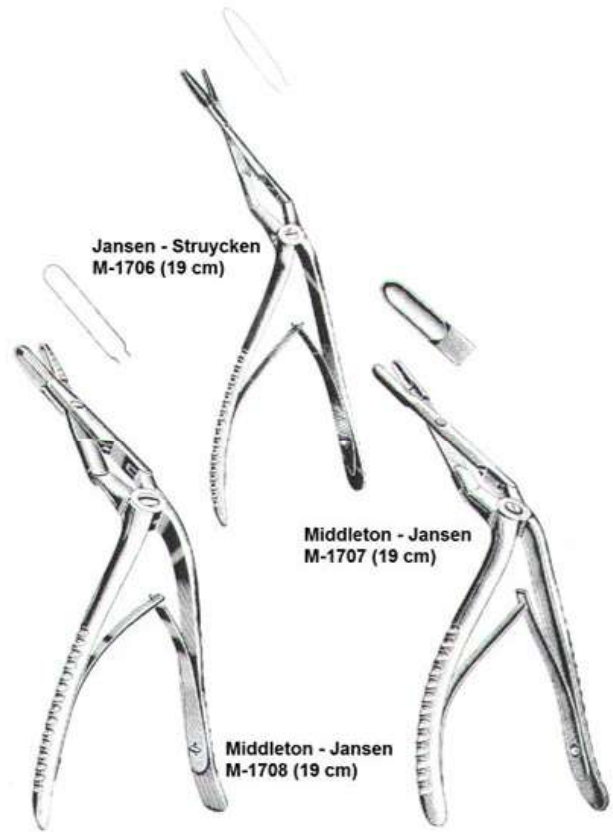

LAMINA SPREADERS

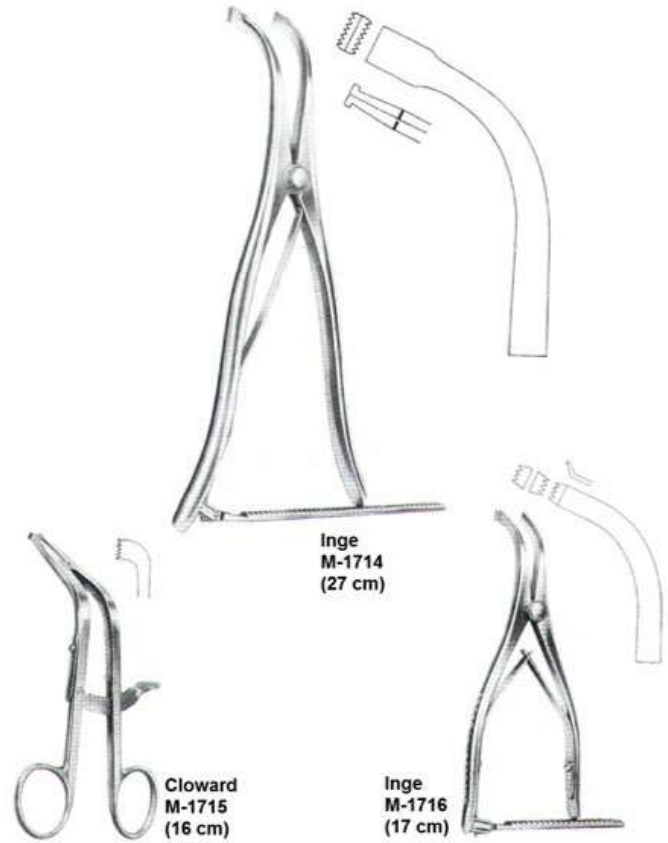

BRONCHUS FORCEPS, LIGATURE FORCEPS

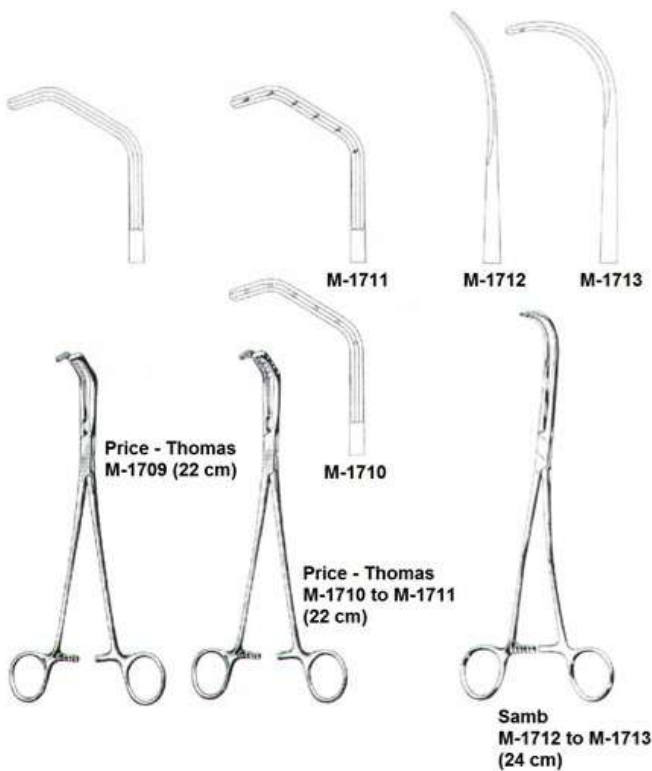

**ANTRUM PUNCH FORCEPS  
SPHENOID PUNCHES**



**BONE PUNCHES**

**ATTICUS PUNCHES**



**CLIP APPLYING FORCEPS**

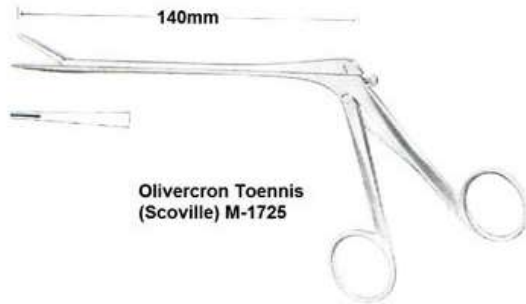

**TISSUE & ORGAN HOLDING FORCEPS**

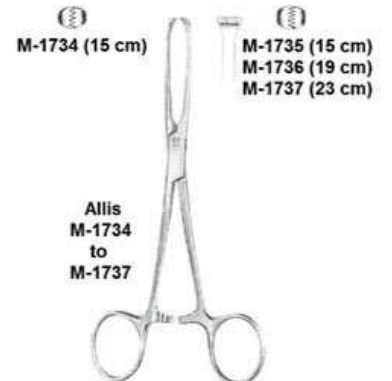
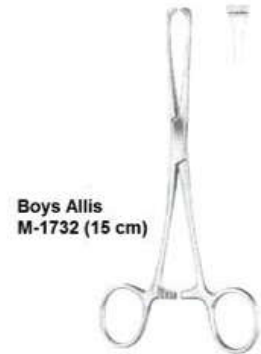
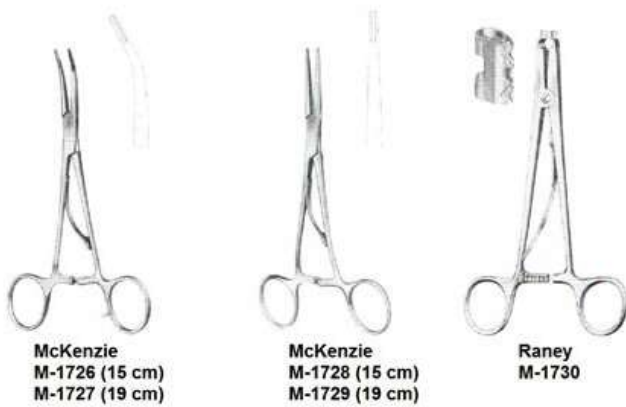

## CERVICAL BIOPSY & SPECIMEN FORCEPS

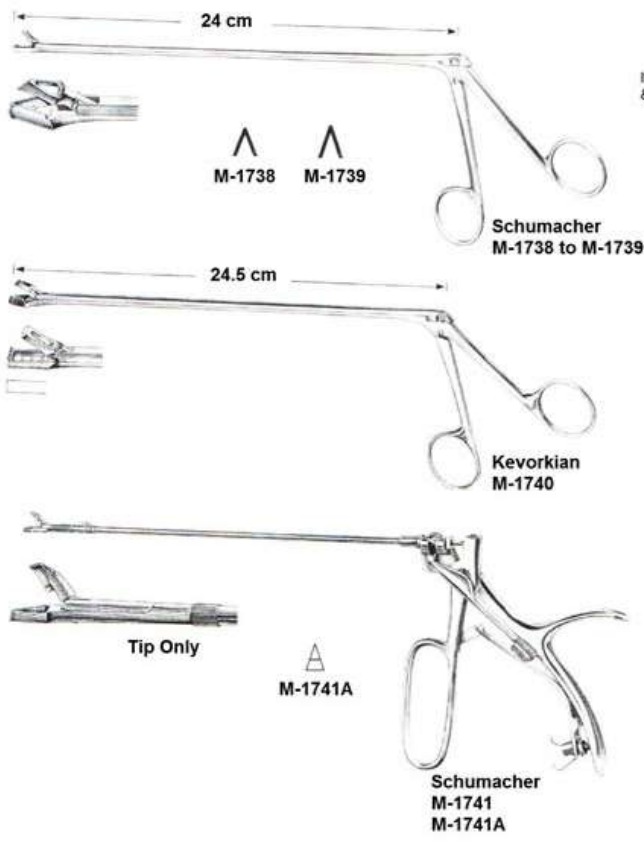

Its S-shaped construction allows clear view & sharply delineated excisions.

Jaws cut with a pulling motion from point to rear. Cutting edge planted into tissue. Better view as jaws are curved to left.

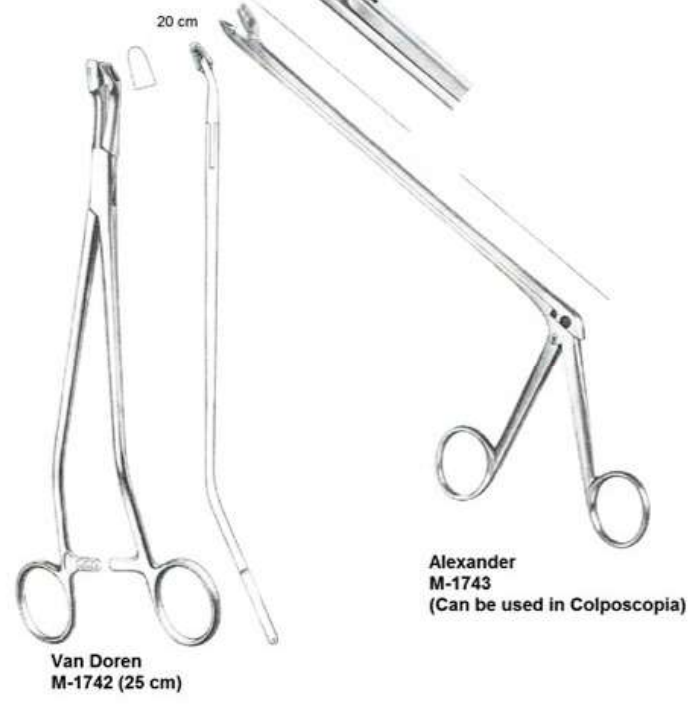

### PUNCHES & RONGEURS

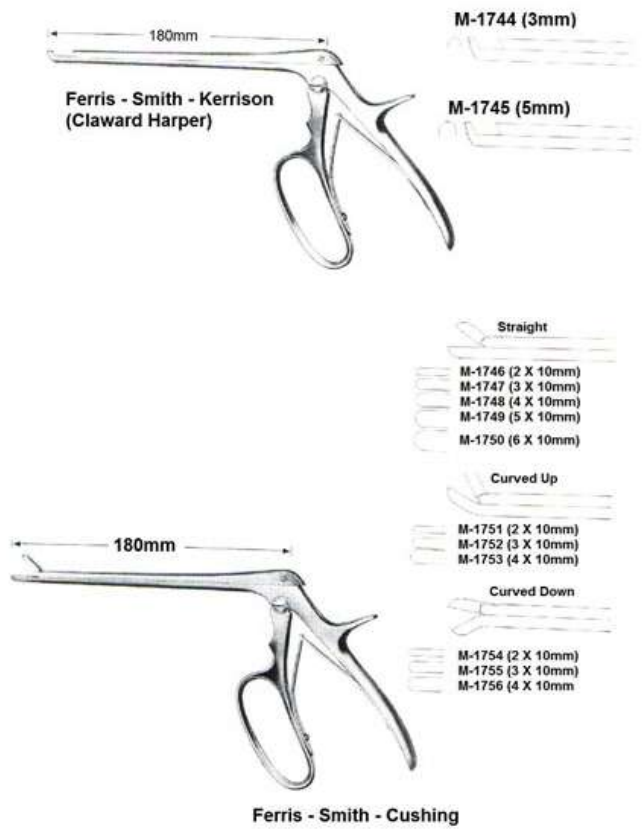

### CERVICAL BIOPSY & SPECIMEN FORCEPS

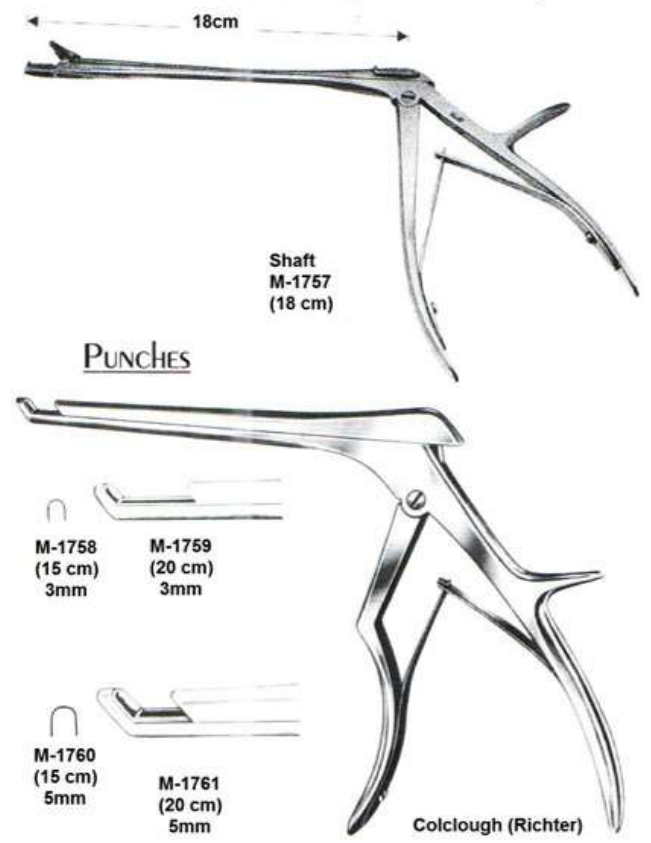

## LAMINECTOMY PUNCHES

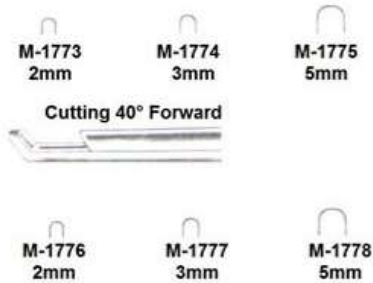
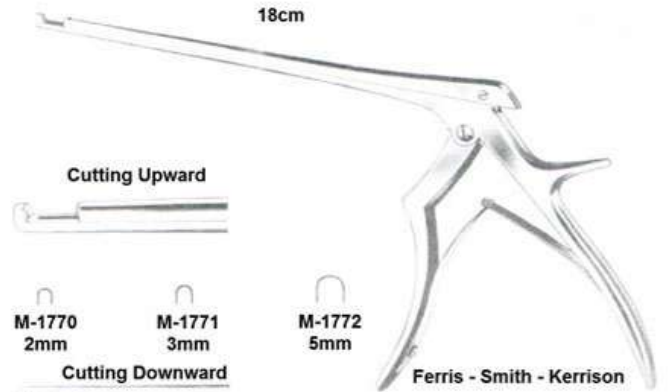
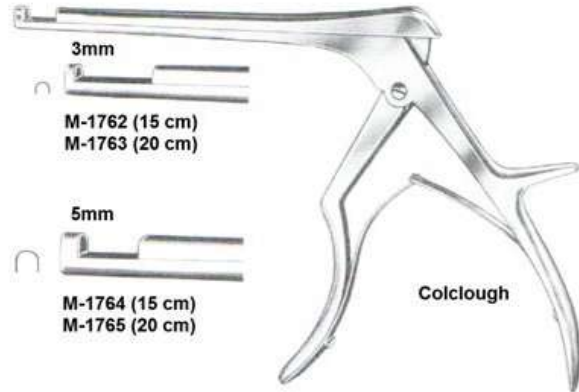

## LAMINECTOMY RONGEURS

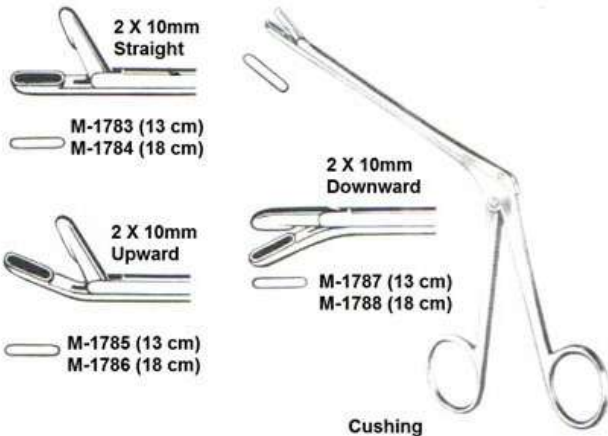

## PUNCHES

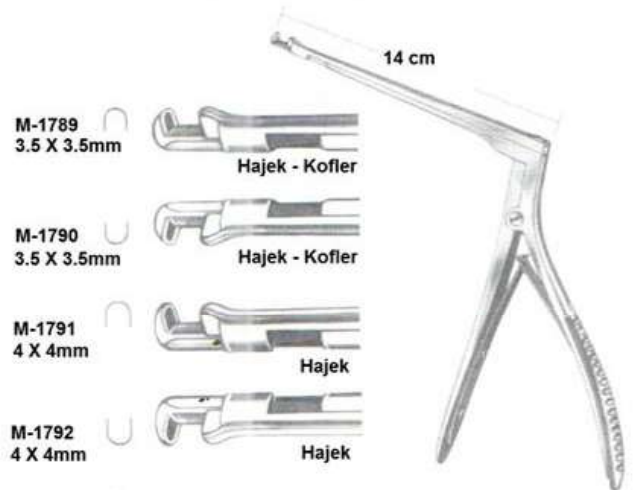

BONE CURETTES

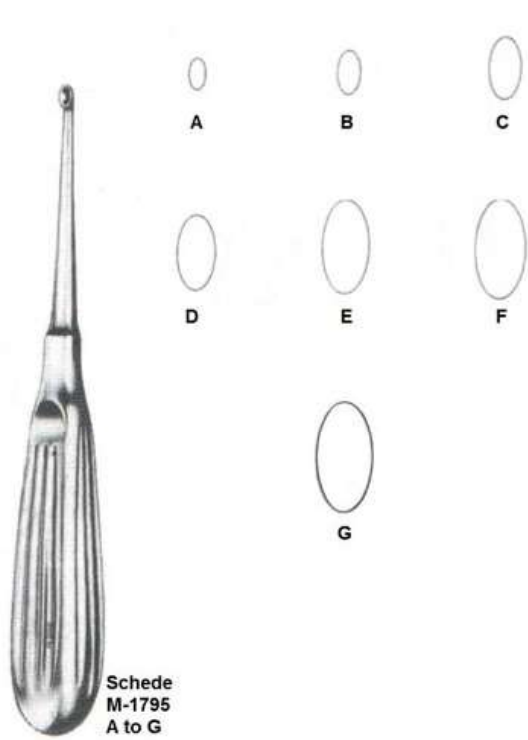

Schede  
M-1795  
A to G

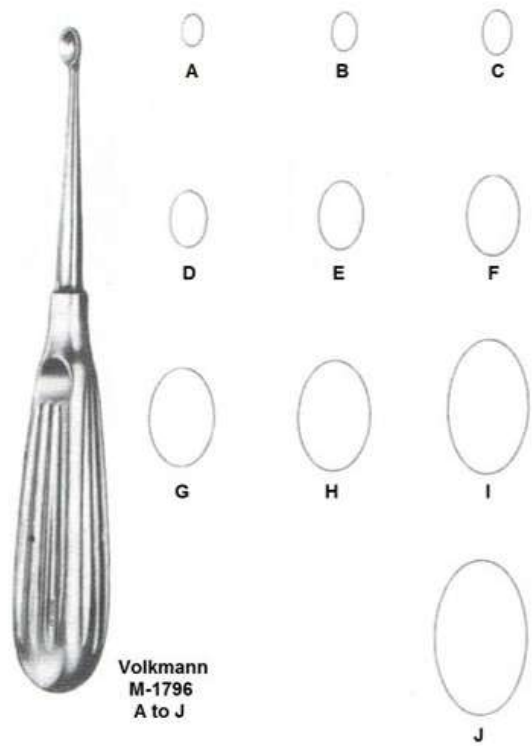

Volkman  
M-1796  
A to J

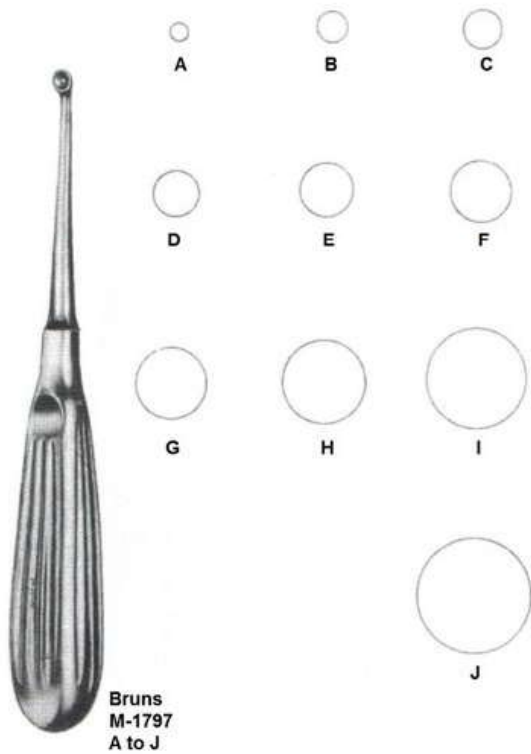

Bruns  
M-1797  
A to J

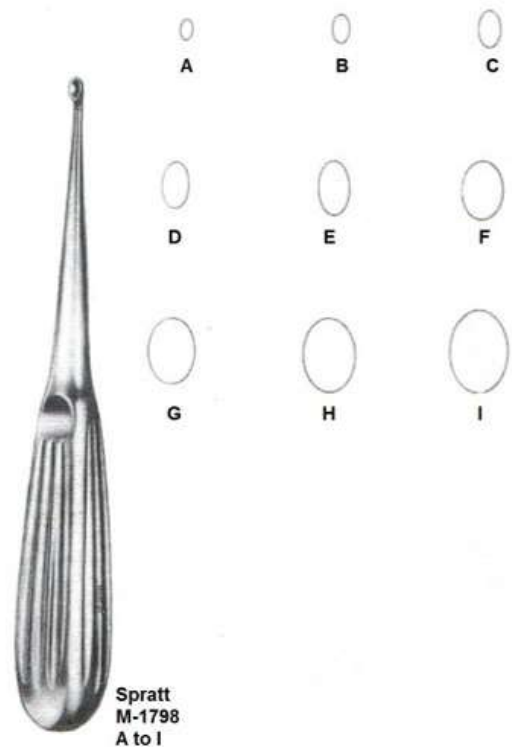

Spratt  
M-1798  
A to I



PLASTER SHEARS, BANDAGE & UTILITY SCISSORS



PLASTER CAST INSTRUMENTS  
PLASTER KNIVES & SAWS

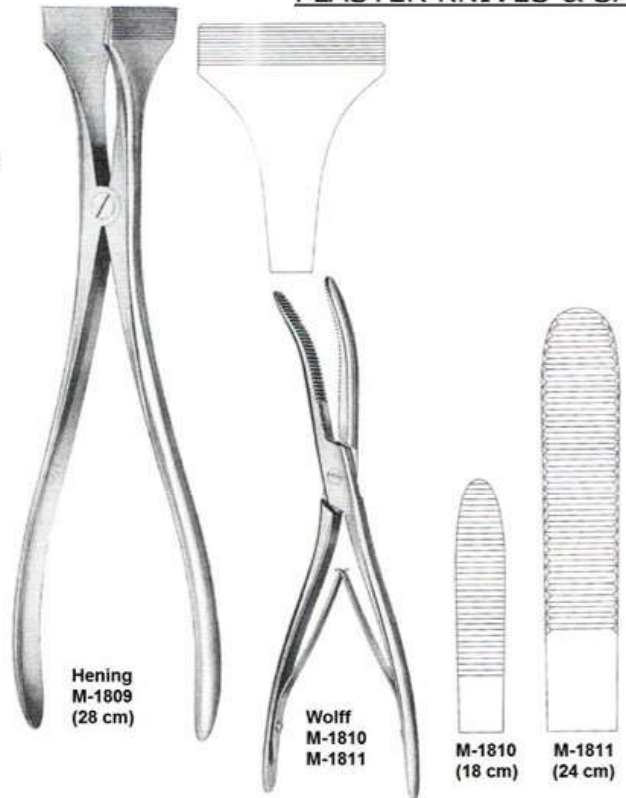

BONE HOLDING CLAMPS  
AMPUTATING & RESECTION SAWS

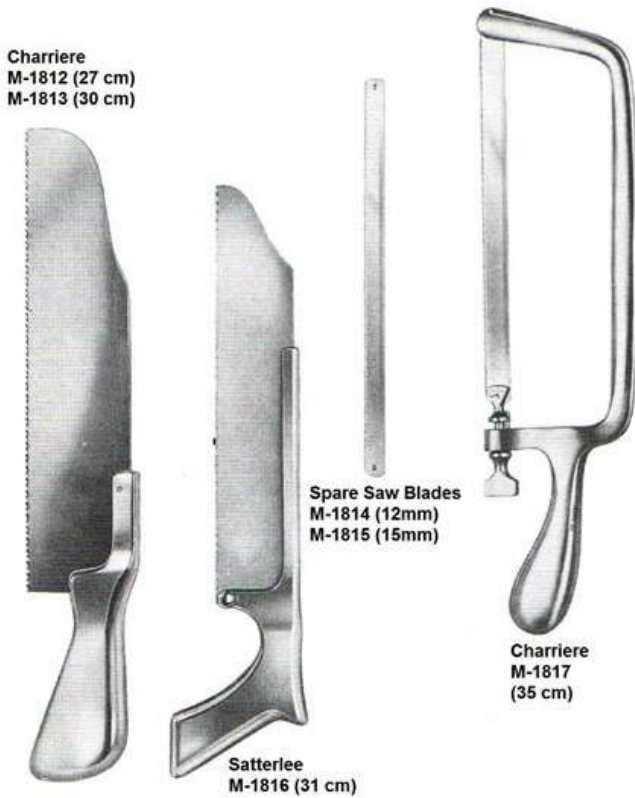

PLASTER CAST INSTRUMENTS, KNIVES, SAWS

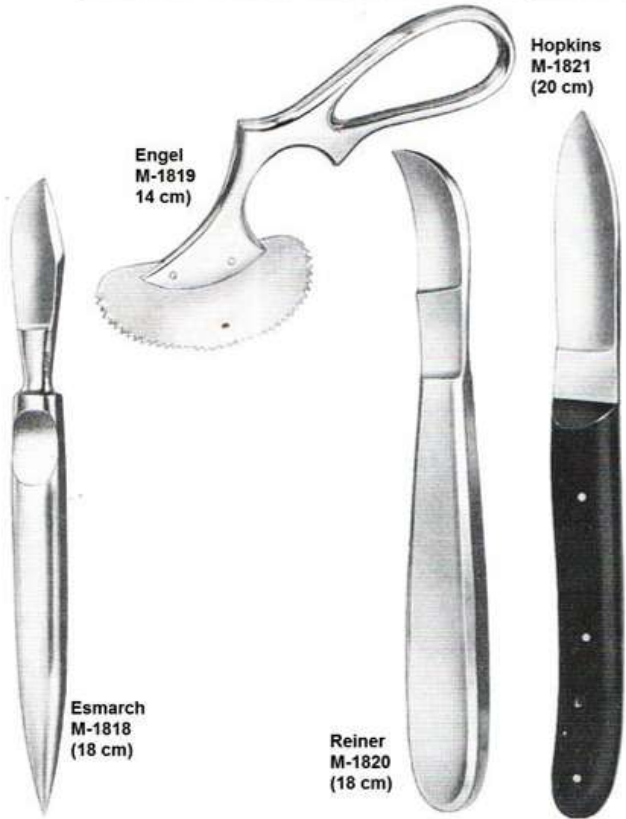

**BONE HOLDING CLAMPS  
AMPUTATING & RESECTION SAWS**

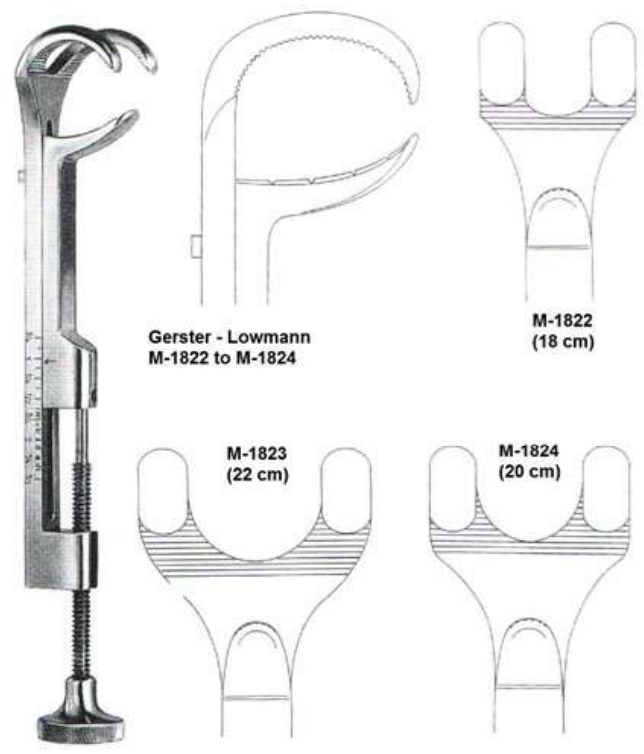

**BONE HOLDING FORCEPS, RETRACTORS**

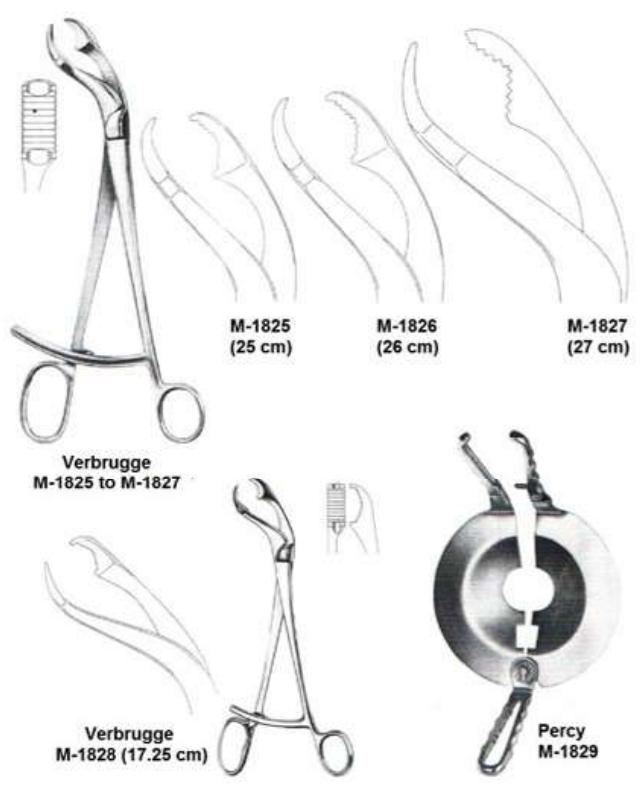

**BONE HOLDING FORCEPS**

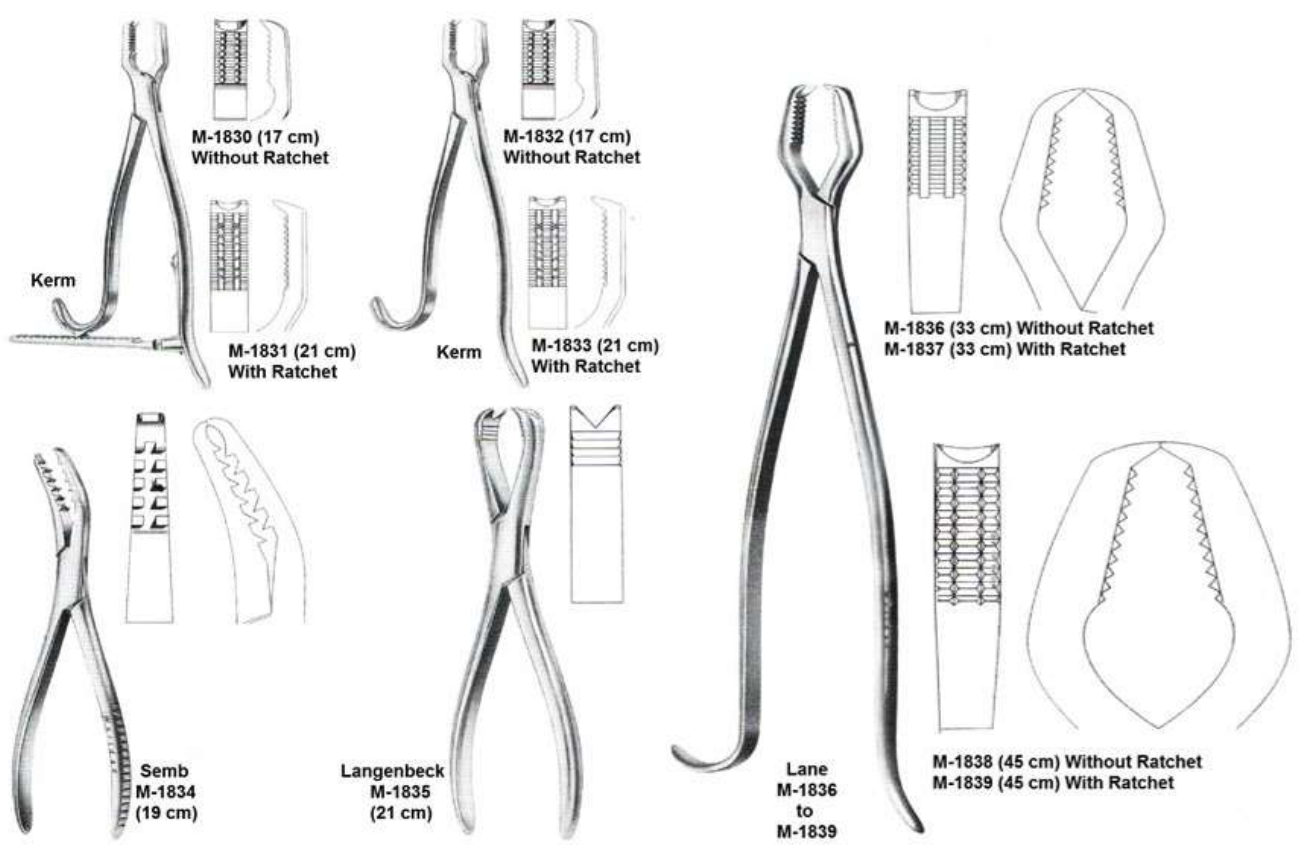

**BONE HOLDING FORCEPS**

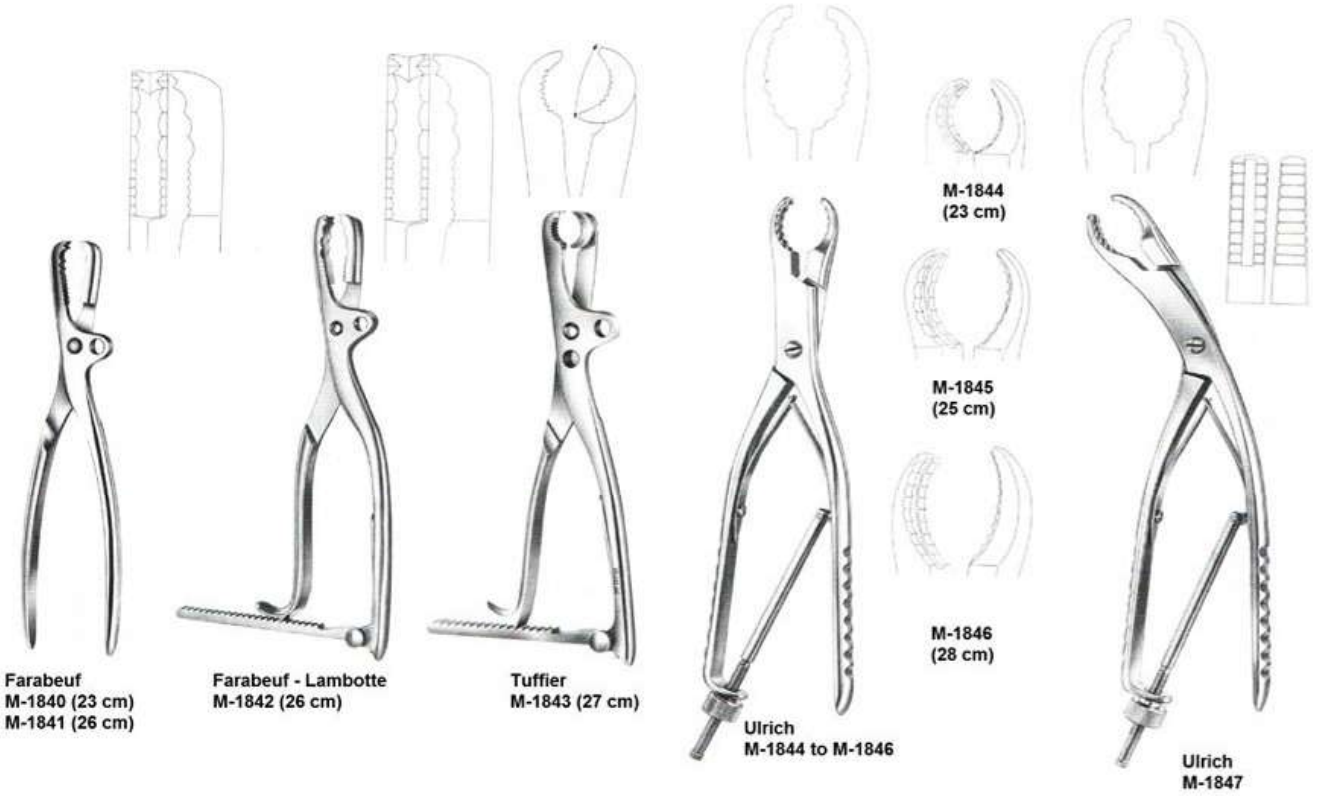

**BONE LEVERS**

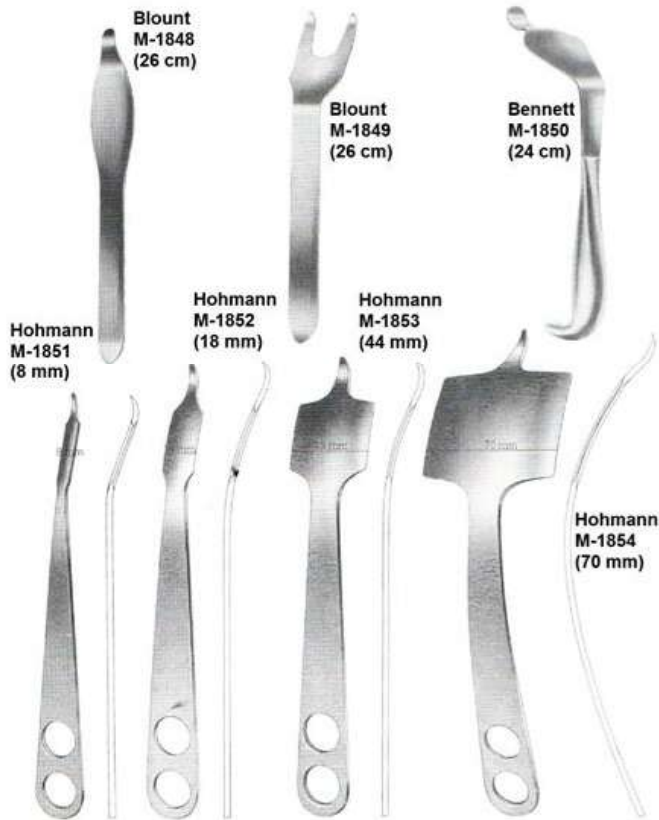

**FLAT NOSE PLIERS**

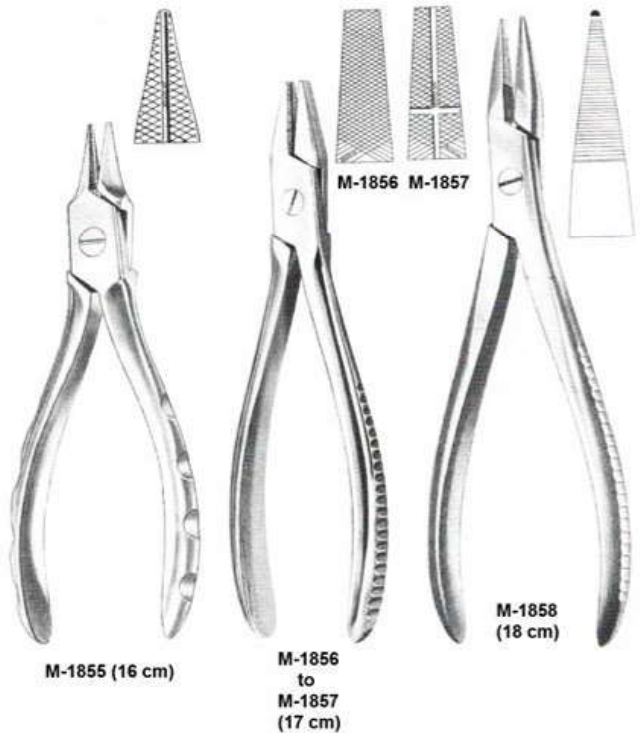

**BONE & RIB SHEARS**



M-1859  
(23 cm)



M-1860  
(22 cm)



Gluck  
M-1861  
(22 cm)



M-1862  
(17 cm)



Stille  
M-1863  
(21 cm)

**RIB CONTRACTORS, LUNG SPATULA**



M-1864  
(19 cm)

Bailey - Baby  
M-1865 (14 cm)



Bailey  
M-1866  
(16 cm)



Bailey - Gibbon  
M-1867 (16 cm)



Allison  
M-1868 (30 cm)  
M-1869 (32 cm)



M-1870  
(26 cm)

**RIB SHEARS, STERNUM SCISSORS,  
STERNUM CHISEL**



Sauerbruch  
M-1871 (26 cm)



Giertz - Stille  
M-1872  
(27 cm)



Sauerbruch - Frey  
M-1873 (36 cm)



Lebsche  
M-1874  
(25 cm)

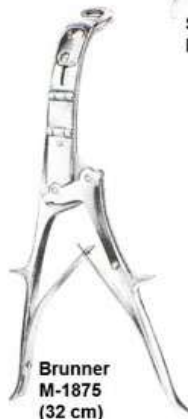

Brunner  
M-1875  
(32 cm)



Lebsche  
M-1876  
(24.5 cm)

**LEAD HANDS, NAIL INSTRUMENTS**

Lead Handsplints

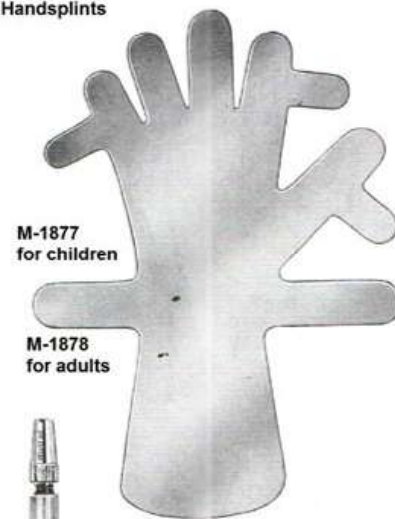

M-1877  
for children

M-1878  
for adults



M-1879  
Feldheim  
(10 cm)



Ideal  
M-1880  
Complete with  
3 drill points



Finger Nail Drill

**BONE CUTTING FORCEPS**

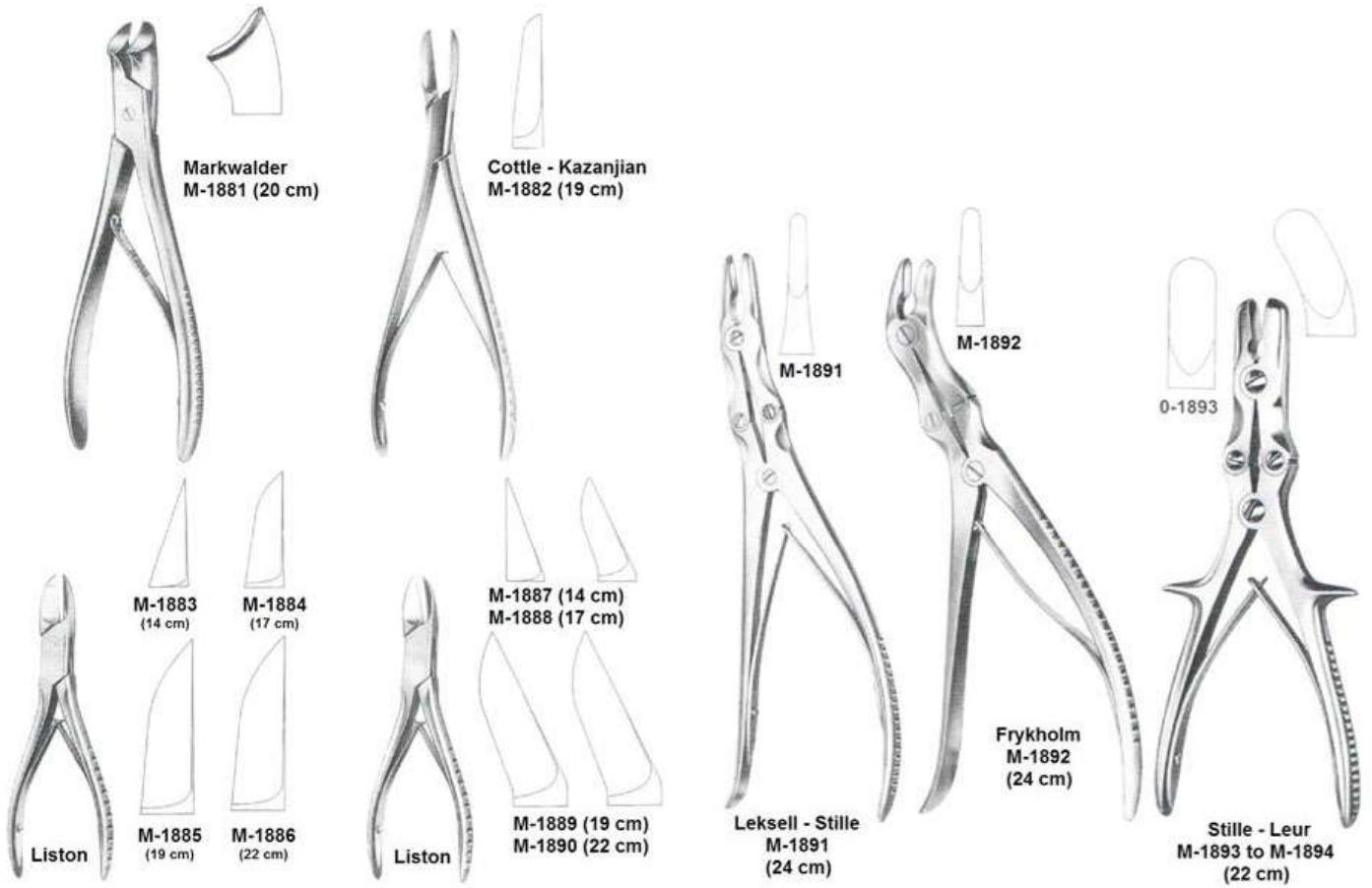

**BONE RONGEUR FORCEPS**

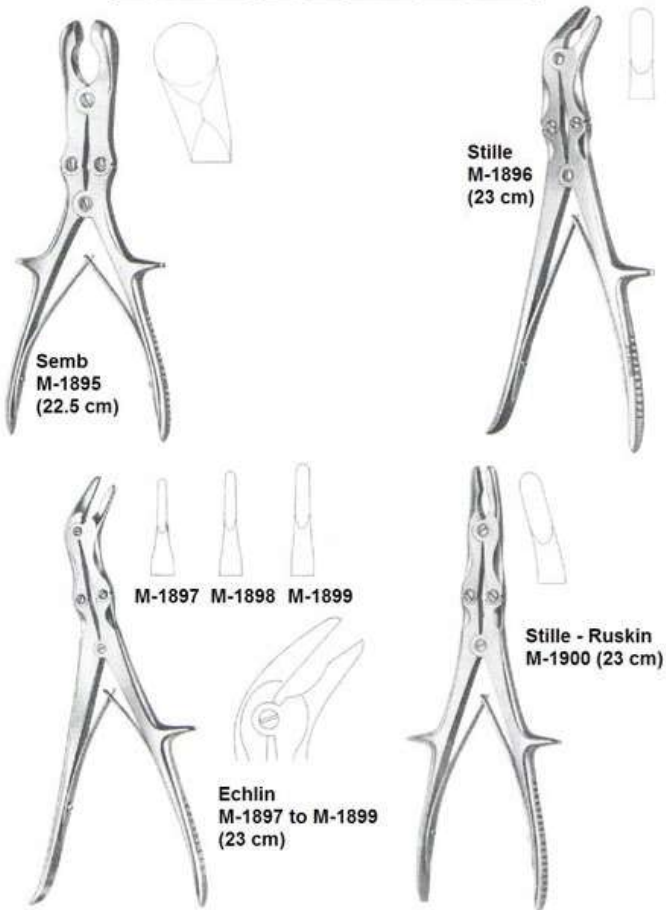

**BONE CUTTING FORCEPS**

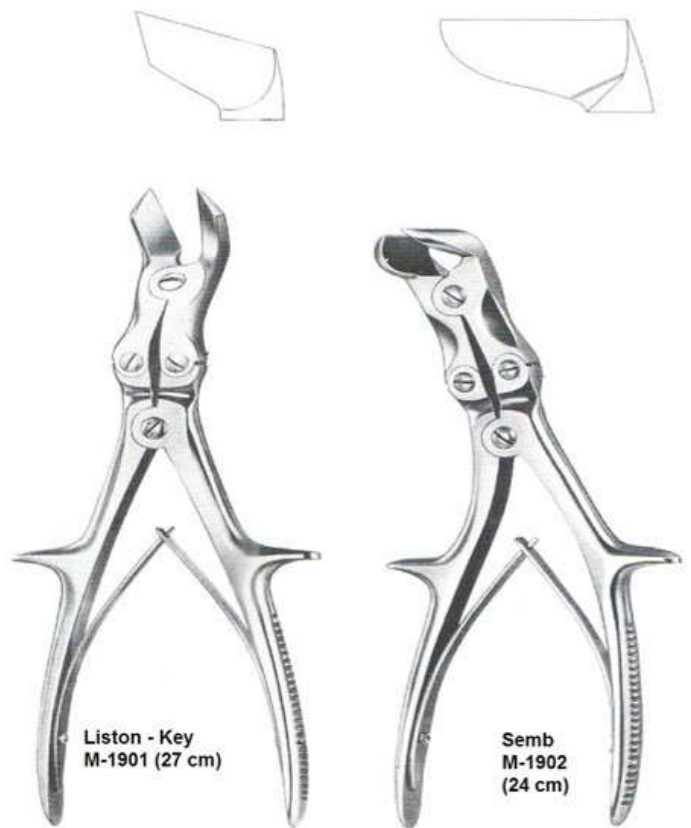

**BONE RONGEUR FORCEPS**

M-1903 (23 cm)  
M-1904 (27 cm)



**Stille - Leur**  
M-1903 to M-1906

M-1905 (23 cm)  
M-1906 (27 cm)

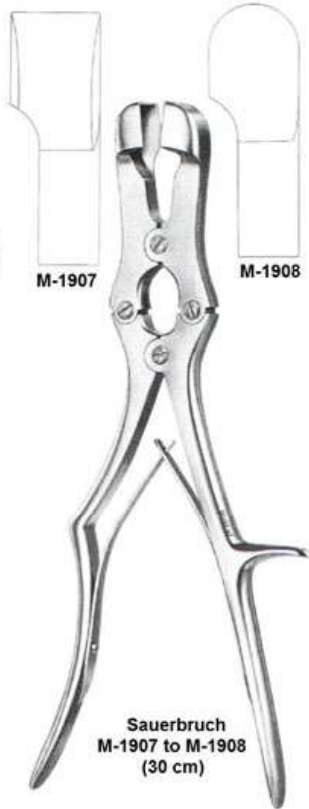

**Sauerbruch**  
M-1907 to M-1908  
(30 cm)

**BONE CUTTING FORCEPS**

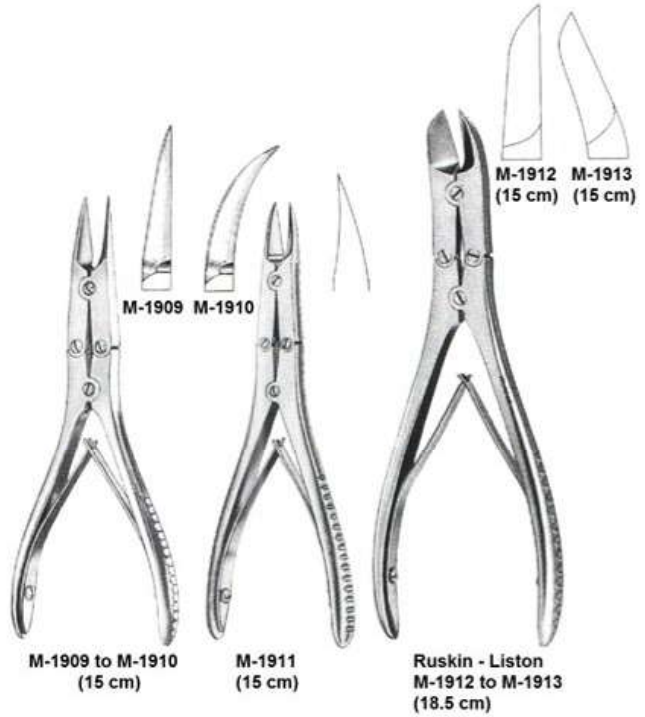

**M-1909 to M-1910**  
(15 cm)

**M-1911**  
(15 cm)

**Ruskin - Liston**  
M-1912 to M-1913  
(18.5 cm)

M-1912 (15 cm) M-1913 (15 cm)

M-1909 M-1910

**BONE CUTTING FORCEPS**

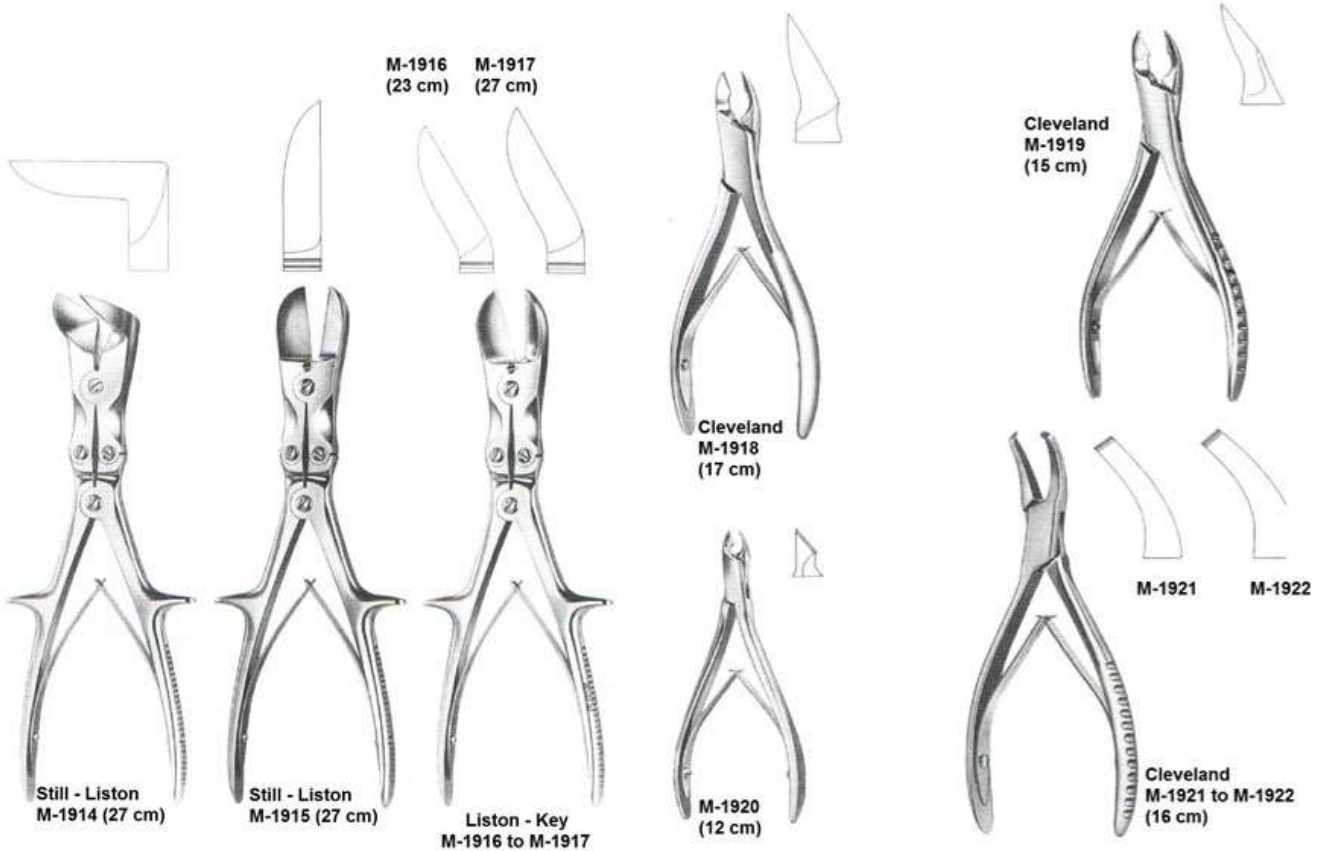

**Still - Liston**  
M-1914 (27 cm)

**Still - Liston**  
M-1915 (27 cm)

**Liston - Key**  
M-1916 to M-1917

**M-1920**  
(12 cm)

**Cleveland**  
M-1918  
(17 cm)

**Cleveland**  
M-1919  
(15 cm)

M-1921

M-1922

**Cleveland**  
M-1921 to M-1922  
(16 cm)

M-1916 (23 cm) M-1917 (27 cm)

**BONE RONGEUR FORCEPS**

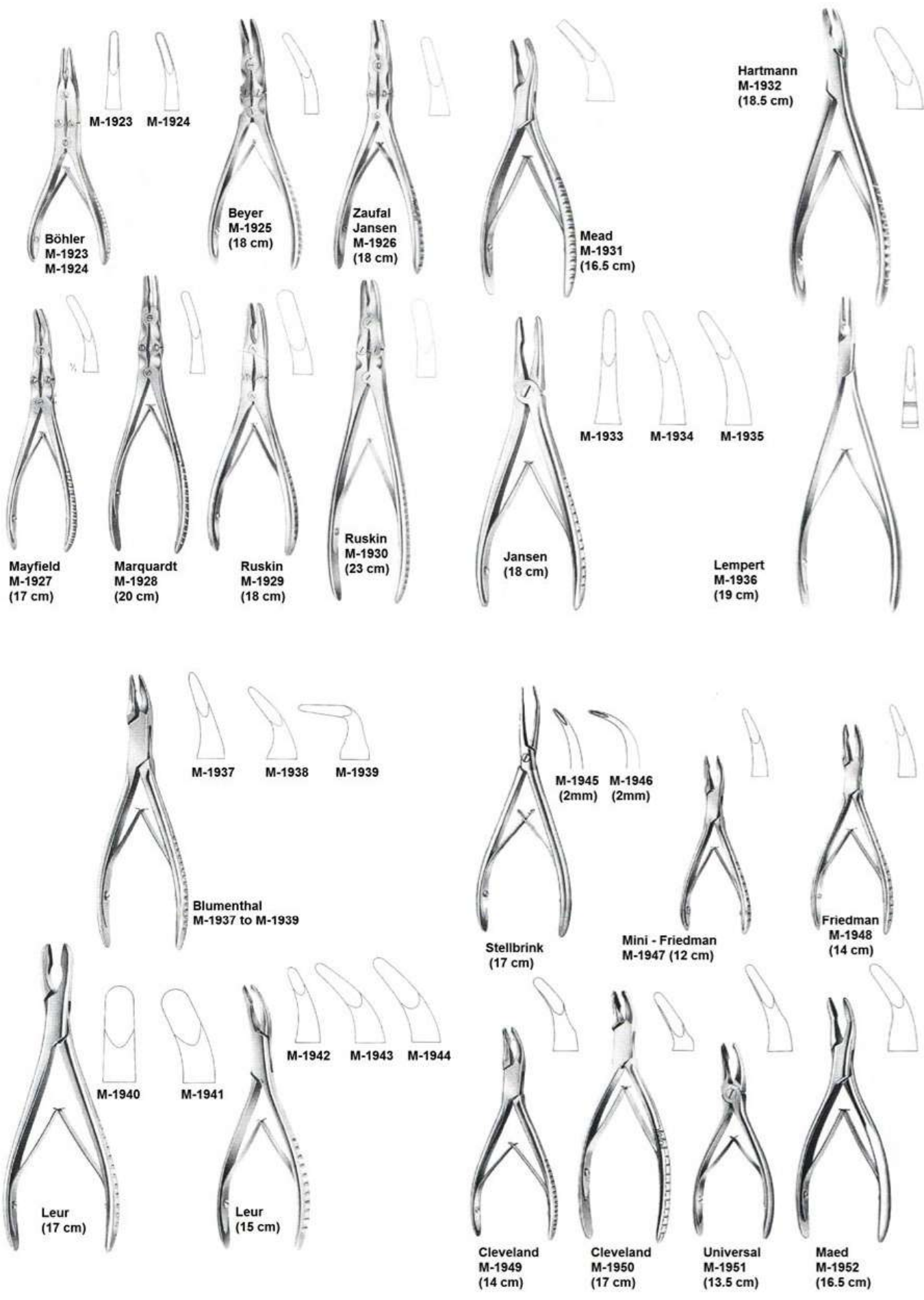

**RASPATOIRES**

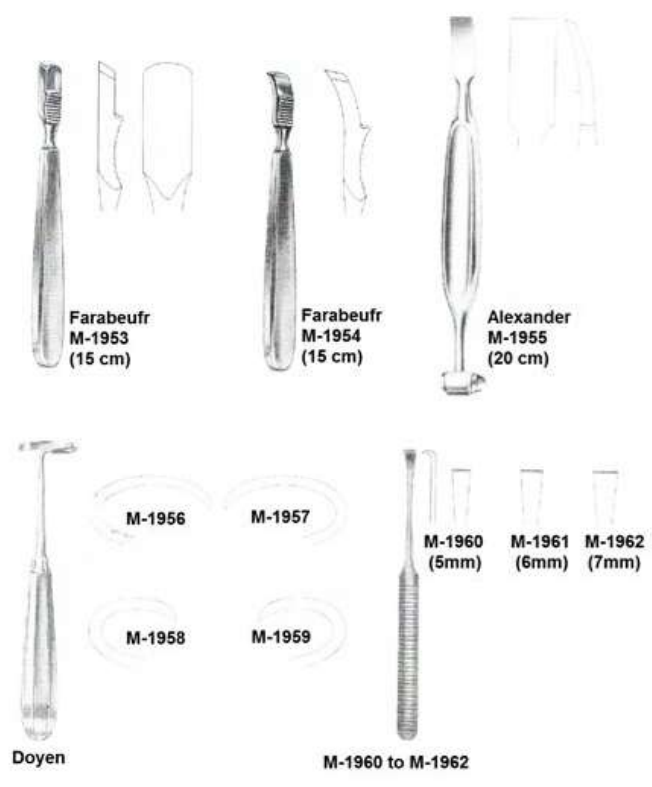

**EXTENSION BOWS  
BONE WIRE TIGHTENERS**

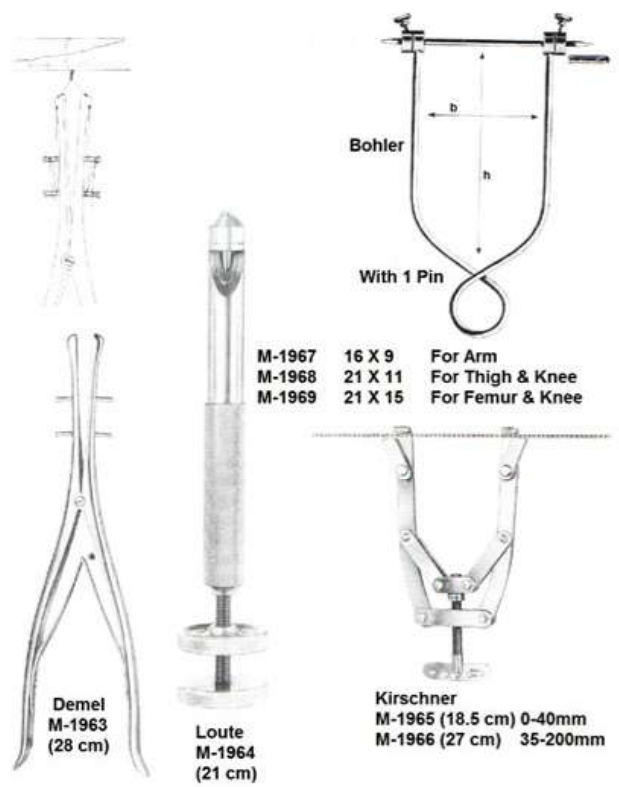

**MALLETS**



**MALLETS, GOUGES & PERIOSTEAL ELEVATORS**

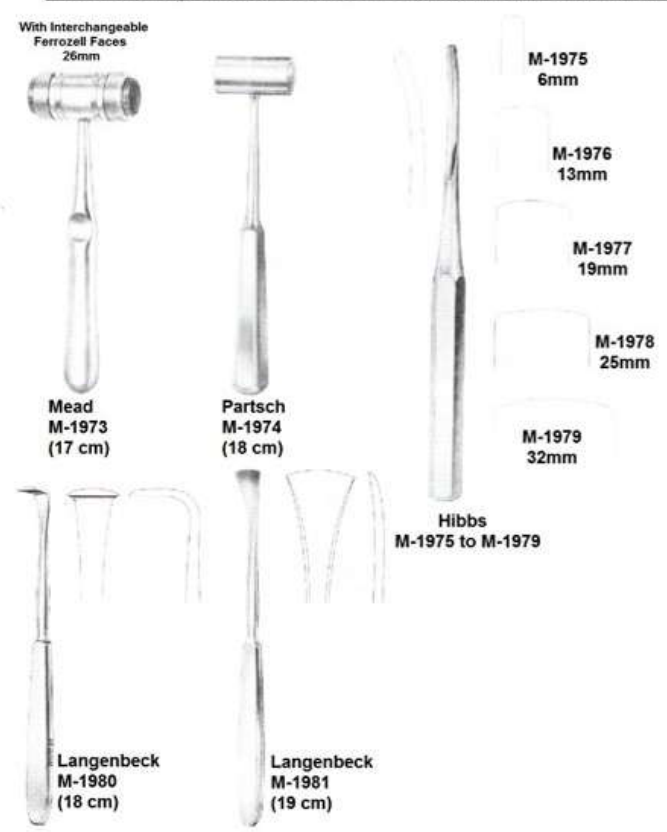



# ALPHABETICAL INDEX

## A

Abdominal Retractors.....	44-45	Blake Gall Stone Forceps.....	60	Cleveland Bone Cutting Forceps.....	75
Abel Tenculum Forceps.....	52	Bladder Retractors.....	42	Cottel Knives .....	03
Abortion Scoops.....	56-57	Blount Bone Levers.....	72	Collier Needle Holders .....	26
Adson (Tissue Forceps).....	17	Blumenthal Bone Rongeur Forceps.....	76	Coxeter Curettes & Spoon .....	07
Adson Brown (Tissue Forceps).....	17	Bone Cutting Forceps.....	74	Cooly Suction Tubes .....	08
Adson(Needle Holder).....	27	Bone Rongeur Forceps.....	75-76	Coakley Trocars.....	09
Adlerkreutz (Tissue Forceps).....	16	Bone & Rib Shears.....	73	Collin Suture Clip Forceps.....	23
Allison( Lung Spatula).....	73	Böhler Bone Rongeur Forceps.....	76	Collin Tissue & Organ Holding Forceps.....	30
Alexander Raspatories.....	77	Bozeman-Dougles Spong		Cottle Rhinoplastic Instruments.....	34
Allis Adair(Tissue intestinal Forceps).....	66	Holding Forceps.....	29	Converse Rhinoplastic Instruments.....	34
Allis Baby(Tissue intestinal Forceps).....	66	Boettcher Tonsil Scissors.....	13	Cottle Walsham Rhinoplastic Instruments... 34	
Alexander Cervical Biopsy & Specimen Forceps).....	67	Bone Levers.....	72	Cottol Kazanjia (Bone Cutting Forceps).....	74
Alan Parks Fiber Optic Anal Retractor.....	41	Bone Holding Clamps.....	71	Collin Vaginal Specula.....	35
Alm Retractor.....	48	Bone Holding Forceps.....	71-72	Cook Rectal Specula.....	41
Aly Algesimeters.....	06	Bozeman Spong Holding Forceps.....	29	Collin Loktite (Abdominal Retractor).....	44
Amputating & Resection Saw.....	70	Böhler Bone Tighteners.....	77	Cooley Rib Spreader From Aluminium .....	44
Amputating Knives.....	01	Bone Punches.....	66	Collin Uterine Elevating Forceps.....	54
Anatomy Dissecting Set.....	05	Boys Allis Tissue Forceps.....	66	Colclough Richter.....	67
Andrew Tongue Depressors.....	31	Bone Curettes.....	69	Colclough Intervertebral Rongeur.....	68
Anal Rectrators.....	39	Bonney Tissue Forceps.....	18	Collin Ovum Curettes .....	56
Antrum Punch Forceps.....	66	BronchoScopis Forceps.....	32	Collin Pelvimeters .....	57
Arruga Needle Holders.....	26	Braun Vaginal Specula & Retractors.....	36	Crile Artery Forceps.....	24
Arruga Capsular Forceps.....	21	Brown Needle Holders.....	27	Crile Needle Holders .....	26
Artery Forceps.....	24-25	Brown Tissue Forceps.....	18	Crile Murray Needle Holders .....	27
Aspirating Curettes.....	65	Brophy Dreesing Forceps.....	16	Crill Wood Needle Holder.....	27
Asch Septum Straightening Forceps.....	34	Brunner Retractors.....	49	Cuscu Vaginal Specula.....	35
Atrauma Sigmoid Anastomosis Forceps.....	63	Braun Tenaculum Forceps.....	52	Cushing Dressing Forceps.....	15
Atrauma Intestinal & Stomach		Braun Utering Elevating Forceps.....	54	Cuzzi Abortion Scoops .....	57
Clamp Forceps.....	63-64	Braun Utering Depressors.....	56	Czerny Tenaculum Forceps.....	54
Autopsy Knives.....	02	Breisky Pelvimeters .....	57	Czerny Gall Stone Forceps.....	58-60
Aufricht Nasal Retractor .....	34-40	Brunner Atrauma Intestinal & Stomach		Czerny Rectal Specula.....	41
Auvarad Vaginal Specula.....	36	Clamp Forceps.....	63		
Ayre Cone Knives.....	55	Bruns Bone Curettes .....	69		
		Braun Forceps.....	51		
		Brunner Rib Shears.....	73		
		Bruenings Tongue Spetula.....	31		
		Buck (Percussion Hammer).....	06		
		Busch Umbilical Scissors.....	14		
		Buck Curettes.....	07		
		Burford Rib Spreaders From Aluminium.....	43		
		Buchwald Tongue Spetula.....	31		

## B

Babinski (Percussion Hammer).....	06
Bakes Gall Duct Dilators.....	59
Basic Dissecting Set.....	05
Barrett Tenaculum Forceps.....	52
Bailey Baby Rib Contractors.....	73
Balfour Abdominal Retractors.....	45
Balfour Baby Abdominal Retractors.....	45
Baby Mixer (Artery Forceps).....	25
Barr Rectal Specula.....	41
Barth Curettes & Spoon.....	07
Barraquer Cilia Forceps.....	18
Ballenger Rhinoplastic Knives.....	03
Barraquer Eye Forceps.....	21
Backhaus Towel Forceps.....	28
Babcock (Tissue Forceps).....	29
Bebe Wire Cutting Scissors.....	14
Beyer Bone Rongeur Forceps.....	76
Bennett Bone Levers.....	72
Berliner Percussion Hammers.....	06
Beyer Bone Punches.....	66
Beulau Trocars.....	09
Beacham Tenaculum Forceps.....	52
Beer cilia Forceps.....	18
Bergh Cilia Forceps.....	18
Bink Horst Capsular Forceps.....	21
Billroth Trocars.....	09
Bishop-Harmon (Iris Forceps).....	20

## C

Castroviejo Suture Forceps.....	21	Cleveland Bone Cutting Forceps.....	75
Castroviejo Needle Holders.....	26	Cottel Knives .....	03
Castroviejo Eye Scissors.....	22	Collier Needle Holders .....	26
Catheter Introducing Instruments.....	53	Coxeter Curettes & Spoon .....	07
Catheter Introducing Forceps.....	08	Cooly Suction Tubes .....	08
Campbell Trocars.....	09	Coakley Trocars.....	09
Capsular Forceps.....	21	Collin Suture Clip Forceps.....	23
Cataract Knives .....	03	Collin Tissue & Organ Holding Forceps.....	30
Cervical Biopsy & Specimen Forceps.....	61-67	Cottle Rhinoplastic Instruments.....	34
Charriere Bone Saw.....	70	Converse Rhinoplastic Instruments.....	34
Chevalier Jakson Trachia Tubes.....	08	Cottle Walsham Rhinoplastic Instruments... 34	
Chalazion Forceps.....	21	Cottol Kazanjia (Bone Cutting Forceps).....	74
Cheattle Sterilizing Forceps.....	28	Collin Vaginal Specula.....	35
Cheek & Lip Retractors.....	31	Cook Rectal Specula.....	41
Cheron Sponge Holding Forceps.....	29	Collin Loktite (Abdominal Retractor).....	44
Chevallier-Jackson		Cooley Rib Spreader From Aluminium .....	44
(Bronchoscopic Forceps).....	32	Collin Uterine Elevating Forceps.....	54
Child Suture Instruments.....	23	Colclough Richter.....	67
Citelli Bone Punches.....	66	Colclough Intervertebral Rongeur.....	68
Cilia Forceps.....	18	Collin Ovum Curettes .....	56
Cloward Lamina Spreaders.....	65	Collin Pelvimeters .....	57
Clips Applying Forceps.....	66	Crile Artery Forceps.....	24
		Crile Needle Holders .....	26
		Crile Murray Needle Holders .....	27
		Crill Wood Needle Holder.....	27
		Cuscu Vaginal Specula.....	35
		Cushing Dressing Forceps.....	15
		Cuzzi Abortion Scoops .....	57
		Czerny Tenaculum Forceps.....	54
		Czerny Gall Stone Forceps.....	58-60
		Czerny Rectal Specula.....	41

## D

Derf Needle Holder .....	26
Desmarres Eye Forceps.....	21
Dejerine Hammers .....	06
Deaver Operating Scissors.....	10
Dean Tansil Scissors.....	13
Deaver Retractors.....	39-49
Delee Forceps.....	51
Desjardins Gall Stone Scoops.....	58-59
Desjardins Gall Duct Dilators.....	59
Demel Bone Wire Tighteners.....	77
De Bakey Tissue Forceps.....	19
Diagnostics Set.....	04
Diacission Knives.....	03
Dissecting Set.....	05
Dilating Bougies.....	53
Dittel Dilating Bougies.....	53
Dissecting Scissors.....	11-12
Doyen Probes.....	07
Doyen Operating Scissors.....	12
Doyen Vaginal Specula.....	36
Doyen Uterine Froceps.....	54
Doyen Tenaculum Forceps.....	55
Doyen Atrauma Intesting & Stomach	
Clamp Forceps.....	64
Doyen Raspatoires.....	77
Duehrssen Dressing Forceps.....	16
Douglas Cilia Forceps.....	18
Douglas Trocars.....	09
Dressing Forceps.....	15-16
Dressing Jarr .....	80
Duval lung Forceps.....	29
Duke Trocars.....	09
Dupaly Tenaculum Forceps .....	52
Dust Bin.....	81

# ALPHABETICAL INDEX

## E

Ear Dressing Forceps.....32  
 Ear Polypus Snares .....33  
 Echlin (Bone Rongeur Forceps).....74  
 Elevating Spoons.....60  
 Electric Sterilizer Boiler Hand Made .....78  
 Elliot Forceps.....51  
 Elschmig (Grasping Forceps).....21  
 Elsasser (Nephrostomy Forceps).....58  
 Eng.pattern (Dressing Forceps).....15  
 Eng.Pattern (Tissue Forceps).....16  
 Engel (Plaster Saws).....70  
 Enema Cane .....80  
 Esmarch Plaster Of Paris Knives.....3  
 Esmarch (Plaster Cast Instruments).....70  
 Extension Bows.....77  
 Eye Scissors.....13  
 Eye Knives.....03

## F

Farabeuf (Raspatories).....77  
 Farabeuf (Bone Holding Forceps).....72  
 Farabeuf-lambotte (Bone Holding Forceps).....72  
 Faure (Cervical Biopsy Specimen Forceps).....61  
 Falcão (Grasping Forceps).....21  
 Feilchenfeld (Splinter Forceps).....19  
 Fergusson (Viginal Specula).....35  
 Fergusson (Gall Stone Scoops).....59  
 Fehland (Atruma Sigmoid).....63  
 Ferris (Laminectomy Punches).....68  
 Ferris-Smith-kerrison Punches.....68  
 Ferris-Smith-Cushing Rongeur.....68  
 Feldheim (Nail Instruments).....73  
 Filiform (Dilating Bougies).....53  
 Finocchietto-Infant (Rib Spreaders).....43  
 Fistula Hooks & Cone Knife.....55  
 Fixation & Grasping Forceps.....21  
 Finocchietto (Rib Speraders).....43  
 Fig (Rhino Plastic Knives).....3  
 Fox (Eye Scissors).....13  
 Foerster (sponge Holding Forceps).....29-30  
 Fomon (Rhino Plastic Knives).....34  
 Fleurant Trocars.....09  
 Frykhoin (Bone Cutting Forceps).....74  
 Friedman (Bone Rongeur Forceps).....76  
 Fritsch (Retractors) .....46  
 Freer (Rhino Plastic Knives).....03  
 Frazier (Suction Tubes).....08  
 Friedman (Endospecula).....52  
 Fuchs (Suture Forceps).....21

## G

Gall Stone Catheters.....58  
 Gall Stone Scoop.....59  
 Gall Stone Forceps.....58-60  
 Gerster (Bone Holding Clamps).....71  
 Gellhorn (Cervical Biopsy & Specimen Forceps).....61  
 Gerald (Dressing Forceps).....15  
 Giertz Still (Rib Shears).....73  
 Gluck (Rib Shears).....73

Gosset (Abdominal Retractors).....45  
 Goelet(Retractors).....50  
 Graefe (Iris Forceps).....20  
 Gradle (Cilia Forceps).....18  
 Grave(Viginal Specula).....35  
 Graefe Forceps.....21  
 Guy (Tongue Holding Forceps).....30  
 Guyon Dialating Bougies.....53  
 Gynecological Scissors.....11

## H

Halsey Needle Holders.....27  
 Hartmann (Ear Polypus Forceps).....32  
 Hartmann Noyes(Ear Polypus Forceps).....32  
 Hartmann-Hoffmann (Ear Polypus Forceps).....32  
 Hartmann-Wullstein (Ear Polypus Forceps).....32  
 Hartmann (Bone Rongeur Forceps).....76  
 Hartmann-Weingartner (Ear Polypus Forceps).....32  
 Halsted-Mosquito (Artery Forceps).....24  
 Hartman (Artery Forceps).....25  
 Hartmann (Tuning Forks).....06  
 Hank (Uterine Diallators).....62  
 Hayes (Atruma Sigmoid Anastomosis Forceps).....63  
 Hajek-Claus (Antrum Punch Forceps).....66  
 Hajek (Punches).....68  
 Haas (Tongue Depressor).....31  
 Heany (Needle Holders).....27  
 Henny Artery Forceps.....25  
 Hess (Iris Forceps).....20  
 Heger Baumgartner (Needle Holders).....27  
 Heymann (Nasal Scissors).....12  
 Henny (Cilia Forceps).....18  
 Heganbarth (Suture Instruments).....23  
 Hennig (Plaster Cast Instruments).....70  
 Heister (Mouth Gags).....31  
 Henrotin (Tenaculum Forceps).....55  
 Heywood-Smith (Haemorrhoidal Forceps).....61  
 Hirth (Catheter introducing Forceps).....58  
 Hibbs (Mallets Gouges).....77  
 Hosemann (Artery Forceps).....25  
 Holsher (Retractor).....48  
 Hohmann (Bone levers).....72  
 Hunter (Splinter Forceps).....19

## I

Ideal (lead Hand).....73  
 Incision Scissors.....10  
 Instruments Tray.....79  
 Instruments Box (Perforated).....78  
 Iris Forceps.....20

## J

Jamison ( Needle Holders).....27  
 Jansen ( Ear Spoon).....07  
 Jansen (Ear Dressing Forceps).....32  
 Jansen (Bone Rongeur Forceps).....76  
 Jansen-Struyckeh, Septum Compression Forceps).....65  
 Jansen (Retractors).....48  
 Jackson (Retactors).....37  
 Jacobs (Tenaculum Forceps).....55

## K

Kane (Ovum Curettes).....56  
 kallmorgen (Vaginal Specula).....37  
 Kelly (Retractor).....51  
 Kelly (Tenaculum Forceps).....54  
 Kelly (Dissecting Scissors).....11  
 Kerrison (Punch Forceps).....66  
 Kevorkian (Specimen Forceps).....67  
 Kevorkian (Suction Biopsy Curettes).....56  
 Keratomes (Knives).....03  
 Kelly Artery Forceps).....25  
 Kelly-Rankin Artery Forceps.....25  
 Kelly (Anal Retrortors).....39  
 Kelly (Retractors).....39  
 Kelsey (Rhinoplastic Instruments).....40  
 Kirschner (Extension bows).....77  
 Kidney Tray.....79  
 Kielland (Midwifery Forceps).....51  
 Kilner (Nasal Scissors) .....12  
 Kilner (Rhinoplastic Instruments).....34  
 Killian (Nasal Specula).....33  
 Kloosterman (Transcervical Aspiration Instruments).....56  
 Kocher (Bladder Retractor).....42  
 Kogan (Retactor).....52  
 Kocher (kidney Forceps).....58  
 Kocher (Artery Forceps).....24  
 Kocher-Rochester (Artery Forceps).....24  
 Kocher-Atrauma (Intestinal & Stomach Clamp Forceps).....64  
 Krause (Trocars).....09  
 Krause (Ear Polypus Snares).....33  
 Krause Voss (Ear Polypus Snares).....33  
 Kressner (Rhinoplastic Instruments).....34  
 Kristeller (Vaginal Specula).....37  
 Kristeller (Retractors).....37

## L

Langenbeck (Resection Knives).....02  
 Lange (Suture Instruments).....23  
 Lamina (Spreader).....65  
 Laminectomy Punches.....68  
 Laminectomy Rongeur.....68  
 Langenberk (Bone Holding Forceps).....71  
 Langenberk (Periosteal Raspatories).....77  
 Langenberk-Green (Retractors).....48  
 Langenbeck (Curettes).....07  
 Landau (Trocars).....09  
 Landolt (Eye Scissors).....13  
 Lane (Tissue Forceps).....18  
 Laryngeal (Polypus Forceps).....32  
 Legueu (Bladder Retractors).....42  
 Lester (Fixation Grasping Forceps).....21  
 Lebsche (Sternum Chisel).....73  
 Lebsche (Sternum Scissors).....73  
 Leksell-Stillle (Bone Cutting Forceps).....74  
 Liston (Bone Cutting Forceps).....74

# ALPHABETICAL INDEX

- Lister (Plaster Shears)..... 70  
 Liston-Key (Bone Cutting Forceps)..... 74-75  
 Lichtwitz (Trocrs)..... 09  
 Lichtenberg (Micro Needle Holder)..... 28  
 Ligature Scissors..... 13  
 Lorma (Towel Forceps)..... 28  
 Lockin (Operating Scissors)..... 14  
 Love-Gruenwald (Laminectomy Rongeurs)..... 53  
 Lovelace (Organ Holding Forceps)..... 29  
 Loute (Bone Wire Tightner)..... 77  
 Lotion Bowl..... 78  
 Luccae (Larynging Polypus Forceps)..... 32  
 Luer (Bone Rongeur Forceps)..... 76  
 Lure-koerte (Gall Stone Scoop)..... 59  
 Lurz (Ureter Calcepus Forceps)..... 60  
 Luer (Bone Rongeur Forceps)..... 76  
 Luer (Rectal Biopsy Speciman Forceps)..... 61
- ## M
- Mayoma Instruments..... 55  
 Mayo (Instruments Tray)..... 79  
 Martin Alloy Hammer..... 06  
 Mayo-Still (Operating Scissors)..... 10  
 Mayo (Operating Scissors)..... 10  
 Mayfield (Bone Rongeur Forceps)..... 76  
 Marquardt (Bone Rongeur Forceps)..... 76  
 Mathieu (Micro Needle Holder)..... 28  
 Mathieu (Vaginal Retractor)..... 37  
 Mathieu (Foreign Body Forceps)..... 53  
 Mayo (Gall Stone Scoop)..... 59  
 Mayo-Robson-Altrauma Forceps..... 64  
 Mayo-Blake (Gall Stone Forceps)..... 60  
 Markwalder (Bone Cutting Forceps)..... 74  
 Mallets (Gauges)..... 77  
 Mathieu (Rectal Specula)..... 41  
 Mathieu (Retractor)..... 50  
 Masson (Needle Holder)..... 27  
 Mayo-Hegar (Needle Holder)..... 27  
 Mcindoe (Dressing Forceps)..... 15  
 Mcintosh (Laryngoscope Set)..... 04  
 Mcintosh (Laryngoscope Blades)..... 04  
 Mc Lean (Midwifery Forceps)..... 51  
 Metal Handle (Autopsy Knives)..... 02  
 Metal Catheters..... 53  
 Metzenbaum(Dissecting Scissors)..... 11  
 Metzenbaum-Delikate (Dissecting Scissors)..... 11  
 Metzenbaum-Nelson(Disecting Scissors)..... 12  
 Mead (Bone Rongeur Forceps)..... 76  
 Mead (Mallets)..... 77  
 Metzenbaum (Needle Holder)..... 27  
 Micro Adson (Dressing Forceps)..... 15  
 Micro Scissors..... 22  
 Millin (Bladder Retractor)..... 42  
 \*Middeldorpf (Retractor)..... 46  
 Mini-Roux (Retractor)..... 50  
 Micro Blades (Eye Knives)..... 03  
 Micro (Needle Holders)..... 28  
 Micro (Dissecting Set)..... 05  
 Miller (laryngoscope Blades)..... 04  
 Mini-Friedman (Bone Rongeur Forceps)..... 76  
 Michel (Suture Instrument)..... 23  
 Millin (Prostatectomy Instrument)..... 61  
 Mikulicz (Retractor)..... 51  
 Mixer (Gall Stone Forceps)..... 58  
 Middleton-Jansen (Septum Compression Forceps)..... 65  
 Mobile Hammer..... 06  
 Mouth Gags..... 31  
 Molt (Mouth Gags)..... 31  
 Mod-Wien (Nasal Specula)..... 33  
 Moynihan (Gall Stone Probes)..... 29  
 Mosquito (Artery Forceps)..... 24  
 Moore (Gall Stone Scoop)..... 59  
 Museux (Tenaculum Forceps)..... 54
- ## N
- Nasal Specula..... 33  
 Nasal Scissors..... 12  
 Needle Holders..... 26-27  
 Neuro Duoflex Percussion Hammer..... 06  
 Nelation (Probes)..... 07  
 Nelson (Trocrs)..... 09  
 Nelson (Tissue Forceps)..... 18  
 Negus (Artery Forceps)..... 25  
 Newman (Anal Retractors)..... 39  
 Nevert (Rhinoplastic Instruments)..... 40  
 Neagele (Obstetrical Forceps)..... 51  
 Neagele (Ovum Curettes)..... 56  
 Nephrostomy (Forceps)..... 58  
 Neurosurgical Scissors..... 12  
 Novak (Suction Biopsy Curettes)..... 56  
 Noto (Uterine Polypus Forceps)..... 54
- ## O
- Obstetrical (Midwifery Forceps)..... 51  
 Obwegeser (Retectors)..... 40  
 Obwegeser (Rhinoplastic Instruments)..... 40  
 Ochsner (Thread forceps)..... 23  
 Oiller (Retectors)..... 46  
 Olivercrona (Neuro Surgical Scissors)..... 12  
 Olivecron Toennis (Clips Applying Forceps)..... 66  
 Olsen Hegar (Needle Holders)..... 26  
 Operating Knives..... 01  
 Operating Scissors..... 10-11-12-14  
 Otoscope Set..... 04  
 Ovum (Curettes)..... 56-57
- ## P
- Partsch (Periosteal Elevators)..... 77  
 Parker (Retractor)..... 50  
 Phaneuf (Artery Forceps)..... 25  
 Pean-Rochester ( Artery forceps)..... 24  
 Pennington (Organ Holding Forceps)..... 30  
 Perforated Tray..... 79  
 Pelvimeters..... 57  
 Pestalozza (Ovum Curettes)..... 57  
 Penis Seizing Forceps..... 53  
 Perussion Hammer..... 06  
 Pederson (Vaginal Specula)..... 35  
 Pinard Sensibility Instruments..... 06  
 Pierce Trocrs..... 09  
 Piper (Midwife Forceps)..... 51  
 Plaster Shears..... 70  
 Plaster Cast Instruments..... 70  
 Plaster Knives..... 70  
 Pozzi (Tenaculum Forceps)..... 52  
 Poole (Suction Tube)..... 08  
 Potts-Smith (Dressing Forceps)..... 15  
 Polypus & Sponge Holding Forceps..... 29  
 Post Martim & Brain Knives..... 02  
 Probes..... 07  
 Prostatectomy Instruments..... 61  
 Price-Thomas (Bronchus Forceps)..... 65  
 Punches Forceps..... 67-68  
 Pye-Smith (Sterilizing Forceps)..... 28
- ## Q
- Quire (Foreign Body Leaver)..... 33  
 Quinby (Fine Operating Scissors)..... 13
- ## R
- Raspatories..... 77  
 Randall (Suction Biopsy Curettes)..... 56  
 Raney (Clip Applying Forceps)..... 66  
 Rectal Specula..... 39-41  
 Retractors..... 36-37-38-39-40-46-47-48  
 ..... 49-50-51  
 Reiner (Plaster Knives)..... 70  
 Rectal (Biopsy Specimen Forceps)..... 61  
 Reiner Knives..... 03  
 Resection Knives..... 02  
 Reynolds (Dissecting Scissors)..... 11  
 Recamier (Uterine Curettes)..... 62  
 Resano Atrauma Sigmoid Forceps..... 63  
 Rhinoplastic Knives..... 03  
 Rhinoplastic Instruments..... 34-40  
 Richter Heath (Suture Instruments)..... 23  
 Rib Spreaders..... 42-43-44  
 Rib Contractors..... 73  
 Rib Shears..... 73  
 Ricard (Abdominal retractor)..... 44  
 Richardson (Retractor)..... 39  
 Roeder (Towel Forceps)..... 28  
 Rogge (Sterilizing Forceps)..... 28  
 Roux Retractor..... 50  
 Rose Koning (Mouth Gags)..... 31  
 Ruskin-Liston (Bone Cutting Forceps)..... 75  
 Ruskin (Bone Rongeur Forceps)..... 76
- ## S
- Saenger (Elevating Spoon)..... 60  
 Sattler (Eye Forceps)..... 21  
 Satterlee (Amputing Saw)..... 70  
 Samuel (Vaginal Specula)..... 36  
 Sauerbruch (Rib Shears)..... 73  
 Sauerbruch (Bone Rongeur Forceps)..... 75  
 Scalp Flap Forceps..... 60  
 Schulze-Bergmann (Rectal Specula)..... 41  
 Schroeder (Uterine Scoop)..... 57  
 Schoeder (Tenaculum Forceps)..... 55  
 Schroeder Forceps..... 52  
 Schuberl (Cervical Biopsy Specimen Forceps)..... 61  
 Schede (Bone Curettes)..... 69  
 Schumacher (Curvical Biopsy & Specimen Forcep)..... 67  
 Scherbak (Vaginal Specula)..... 36  
 Schumacher (Umbilical Scissors)..... 14  
 Scoville (Nerve Root Retractor)..... 48  
 Schaedel (Towel Forceps)..... 28  
 Scalpal Handles..... 01  
 Seyffert (Vaginal Specula)..... 35  
 Semm (Vaginal Specula)..... 35  
 Semb (Bone Rongeur Forceps)..... 74

# ALPHABETICAL INDEX

## S

Semb (Bone Holding Forceps).....71  
 Semkin (Tissue Forceps)..... 17  
 Segond (Myoma Instruments)..... 55  
 Secretion Scoops.....53  
 Sellheim (Elevating Spoon)..... 60  
 Septum Compression Forceps.....65  
 Sensibility Instruments.....06  
 Shaft (Curvical Biopsy & Specimen Forcep).....67  
 Shapleigh (Curettes).....07  
 Sims (Vaginal Specula)..... 37  
 Simpson (Midwife Forceps).....51  
 Sims (Uterine Sound).....56  
 Simon (Cone Knives).....55  
 Simon (Pelvimeters)..... 57  
 Simpson-Braun Forceps.....51  
 Simpson-Luikart Forceps.....51  
 Sims (Operating Scissors)..... 12  
 Sims (Gynecological Scissors)..... 14  
 Sims (Rectal Specula)..... 41  
 Skene (Tenaculum Forceps).....52  
 Smith-Buie (Rectal Specula).....41  
 Sökeland (Kidney Forceps)..... 58  
 Somer (Tenaculum Forceps).....54  
 Specimen Forceps..... 67  
 Spencer Wells (Artery Forceps)..... 25  
 Speical- Mod (Nerve Root Retractor)..... 48  
 Splinter Forceps..... 19  
 Spurling(Catheter Introducing Instrument)... 53  
 Sphenid Punches.....66  
 Spratt (Bone Curettes)..... 69  
 Spong Holding Forceps..... 29  
 Sputum Cup.....81  
 Standard Operating Scissors..... 10  
 Standard (Tissue Forceps)..... 17  
 Standard (Trachea Tubes).....08  
 Standard Scalpel Handle.....01  
 Standard Trocars.....09  
 Standard (Dressing Forceps)..... 15  
 Staude-Moore (Tenaculum Forceps).....52  
 Stacke (Probe).....07  
 Sterilizing Forceps..... 28  
 Sternberg (Lip Retractor)..... 31  
 Stellbrink (Bone Rongeur Forceps).....76  
 Stevens (Iris Forceps).....20  
 Sterilizing Drum.....78  
 Sternum (Chiesel).....73  
 Still (Dressing Forceps)..... 15  
 Stratte (Needle Holder)..... 26  
 Strauss (Secretion Scoop).....53  
 Strandell-still (Retractor).....48  
 Stvents (Eye Scissors)..... 13  
 Stockmann (Secretion Scoop).....53  
 Stille-Luer (Bone Rongeur Forceps).....74  
 Stille-luer (Bone Cutting Forceps).....74  
 Stille-liston (Bone Cutting Forceps).....75  
 Stille-Ruskin (Bone Rongeur Forceps)..... 74-75  
 Stille (Rib Shears).....73  
 Suction Biopsy Curettes..... 56  
 Suction Tubes.....08  
 Suture Forceps..... 21  
 Suture Instruments..... 23  
 Surgical Holloware.....78-79-80-81  
 Swiss Pattern (Vaginal Specula)..... 35

## T

Taylor (Dressing Forceps).....15  
 Taylor (Percussion Hammer).....06  
 Teale (Tenaculum Forceps)..... 55  
 Telescopic (Hammer).....06  
 Tenaculum Forceps..... 52-54-55  
 Thomson-Walker (Bladder Retractor)..... 42  
 Thoms-Gaylor (Cervical Biopsy & Specimen Forceps)..... 61  
 Tieck-Halle (Nasal Specula)..... 33  
 Tissue & Organ Holding Forceps.....29  
 Tissue Forceps..... 16-17-18-19  
 Toennis (Needle Holder).....26  
 Toennis Adson (Neurosurgical Scissors).....12  
 Towel Forceps.....28  
 Tongue Holding Forceps.....30  
 Tongue Depressor.....31  
 Tobold (Tongue Depressor).....31  
 Tonsil Snare..... 33  
 Toothed-Back (Ovum Curettes)..... 57  
 Tonsal Scissors.....13  
 Tohoku (Towel Forceps).....28  
 Troemner (Hammer).....06  
 Trachea Tubes.....08  
 Trocars.....09  
 Trelat (Vaginal Specula)..... 35  
 Troeltsch-Wilde (Ear Dressing Forceps)..... 32  
 Tuffier (Bone Holding Forceps)..... 72  
 Turner-Warwick (Gall Stone Forceps).....60  
 Tuffier (Rib Spreader).....43  
 Tunning Forks.....06  
 Tyding (Tonsil Snare)..... 33

## U

Ulrich (Bone Holding Forceps)..... 72  
 Umbical Scissors..... 14  
 Universal (Wire Cutting Scissors)..... 14  
 Universal (Trocars).....09  
 Universal (Bone Rongeur Forceps)..... 76  
 Urinal Male..... 80  
 Urinal Female..... 80  
 Uterine (Polypus Forceps).....54  
 Uterine Elevating Forceps.....54  
 Uterine (Sound & Depressors).....56  
 Uterine Scoops.....57  
 Uterine (Calculus Forceps)..... 60  
 Uterine Dilators..... 62  
 Utility Scissors..... 70  
 Utility Tray..... 79

## V

Vaginal Retractors..... 37  
 Valleix (Uterine Sounds)..... 56  
 Van Doren (Cervical Biopsy Specimen Forceps)..... 61  
 Van Buren (Dilating Bougies)..... 53  
 Anastomosis Forceps)..... 63  
 Volkmann Retractors.....46  
 Volkmann (Bone Curettes).....69  
 Veidenheimer(Atrauma Sigmoid Anastonosis forceps).....63  
 Van Doren (Cervical Biopsy Specimen Forceps).....61  
 Verbrugge (Bone Holding Forceps).....71  
 Virchow (Post Martem Knife).....02  
 Viginal Specula..... 35-36-37-38

## W

Wachenfelet (Suture Instrument).....23  
 Wallich (Abortion Scoops).....56  
 Wash Basin..... 78  
 Wassmund (Retractor).....46  
 Watenberg (Sensibility instruments).....06  
 Water Comalt (Splinter Forceps).....19  
 Weber (Sensibility Instrument).....06  
 Webster (Needle Holder).....26  
 Weissbarth (Vaginal Specula).....36  
 Wertheim (Operating Scissors)..... 11  
 Wheeler (Discission Knives).....03  
 Wire Cutting (gum Scissors).....14  
 Wolff (Plaster Cast Instruments).....70  
 Worth (Eye forceps)..... 21

## Y

Yankaur (Suction Tubes).....08  
 Young (Tongue Holding Forceps).....30

## Z

Zauffal-Jensen (Bone Rongeur Forceps).....76



# FusionKraft™



by

*Myra & Company*

(An ISO 9001 : 2008 Certified Company)

293, Ground Floor, Niti Khand -2, Indirapuram.  
Ghaziabad. U.P.-201010. INDIA

Ph: +91 - 120 - 653 0330 (8 Lines)  
Mob: +91 - 99999 06920, +91 - 98108 13683  
Hotline: +91 - 120 - 640 1193

Email: [org@myraandcompany.in](mailto:org@myraandcompany.in)

[www.myraandcompany.in](http://www.myraandcompany.in)

FusionKraft™ is a trademark of Myra & Co., India. Copyright © 2014 Myra & Co. All rights reserved.

The information presented in this catalogue is intended to demonstrate a FusionKraft™ product only. Myra & Co. reserves the right to make any alterations in the information/technical specifications without any prior notice. No part of this catalogue may be reproduced, stored in or introduced into a retrieval system, or transmitted, in any form or by any means (electronic, mechanical, photocopying, recording, or otherwise) without the prior written permission.